

TRAINING CALENDER 2026-27



SCAN FOR
TRAINING CALENDER



- ← TOOL DESIGN
- ← CAD / CAM / CAE
- ← SOLAR TECHNOLOGY
- ← TOOL MANUFACTURING
- ← 3D PRINTING / SCANNING
- ← CIVIL / ARCHITECTURAL DESIGN
- ← LASER CALIBRATION OF MACHINES
- ← COMPUTER HARDWARE / NETWORKING
- ← ARTIFICIAL INTELLIGENCE / DATA ANALYSIS

- ← AUTOTRONICS
- ← QUALITY ASSURANCE
- ← PRECISION MACHINING
- ← WELDING TECHNOLOGY
- ← MECHATRONICS / ROBOTICS
- ← CNC PROGRAMMING MACHINING
- ← ELECTRICAL / ELECTRONICS GADGETS
- ← LCA - PRODUCT / PROCESS AUTOMATION
- ← WEB DESIGNING / 3D ANIMATION



MSME TECHNOLOGY CENTRE INDO GERMAN TOOL ROOM, AURANGABAD

(A Government of India Society, Ministry of MSME)

AN ISO 9001, ISO 14001, ISO 45001 & ISO 50001
Certified Tool Room & Training Centre



MSME Technology Centre - Indo German Tool Room (IGTR) Chhatrapati Sambhajnagar is a Govt. of India Society, under Ministry of Micro, Small & Medium Enterprises (MSME) Govt. of India. The unique feature of IGTR is the Production & Training activities are under one roof, IGTR is a center, which nurtures excellence and provides Tooling & Training Solutions. The objectives of IGTR is to provide technical support to MSME's by way of providing assistance in Designing, Manufacturing as well as to conduct the Skill Development Training Courses in the area of Tool Design, CAD/CAM/CAE, CNC Programming & Machining, Hydraulics, Pneumatics, PLC, SCADA, VLSI, Embedded Systems, 3D Printing, Mechatronics, Robotics, Low Cost Automation & Welding Technology. The Certifications offered by IGTR are well accepted by Industries and Institutes in India and abroad for employment and higher education purposes. IGTR Aurangabad implements its Skill Development Training Programs through its Chhatrapati Sambhajnagar Training Centre and Sub centers at Pune, Nagpur, Mumbai, Kolhapur & Waluj Chhatrapati Sambhajnagar.

IGTR has ultramodern, state-of-the-art Tool Room facilities under single roof. It is a Dream Tool Room for any Tool Maker. The wide spectrum of sophisticated machines include latest & advance CNC Lathe, Milling, EDM & Wire-Cut, 3D Printing (Metal), 3D Printing (Plastics), 3D Scanner, CNC Jig Grinding, CNC Turn Mill, 5 Axis CNC Mill Turn, High Precision 5 - Axis Machining center, which can cater to various requirements of the customers.

IGTR strongly believes in TQM Philosophy. This belief is evident in the procedures adopted for ensuring quality before and after manufacture. High precision equipment like CNC Co-ordinate Measuring Machine, Electronic Height Master, Profile Projector and Tool Maker's Microscope ensure thorough checking of the components. A full-fledged standards room and NABL Accredited calibration Lab Offers Precision measuring/Inspection of job and Calibration of Measuring instrument services as per standards requirements. In addition, trials of the tools are undertaken on the Mechanical Press and Injection Moulding Machines.

Equipped with state-of-the-art machinery & training facilities, the various activities are :

ACTIVITIES

TOOL DESIGN & MANUFACTURING

- Design and manufacture of precision dies and tools, moulds, Jigs & fixtures, gauges etc. and their appropriate use and maintenance.
- Tool manufacturing using latest technology
- Tool related innovations for improved product design.
- Precision machining and Heat Treatment.
- Tool Trials for Press Tools & Injection Moulds.

TRAINING

- Long / Medium / Short Term Courses In Tool & Die Technology, Automation & Welding.
- Specialized Hi-tech Courses For Engineering Graduates, Diploma, ITI & SSC Passouts.
- Skilled Enhancement Courses For Industry Personnel.
- Skill Up-gradation Courses For Trainers From Institutes.
- Custom Designed Training Programs For International Trainees.

CONSULTANCY & OTHERS

- Product & Process Development
- Productivity / Quality improvement
- Training Programme / Course curriculum development for training institutes
- Execution of Turn-key projects.

QUALITY ASSURANCE

- Precision Measurements with CMM
- Inspection of Tools, Dies, Gauges and Sheet Metal/Plastic Components
- Product Developments Using Reverse Engineering

CALIBRATION SERVICES

- Calibration of Measuring Equipments
 - Vernier Caliper • Micrometer, • Dial Gauges, • Height Gauges, • Depth Gauges
- Laser Calibration of Machines
 - Calibration of linear movements for CNC Machine with renishaw laser calibration machine

PRODUCT DESIGN & DEVELOPMENT

- 3D Printing Plastic
- 3D Printing Metal
- Reverse Engineering
- Model Development with 3D Scanner



Completely equipped with latest CNC & Conventional machines Training Center offers scientifically designed Long, Medium & Short Term Courses in the field of Tool & Die Technology. Scientifically designed curriculum ensure optimum blending of theory and practice using latest pedagogical techniques and teaching Aids by trainers. Training aims at.

- Bridging the gap of trained for 21st Century.
- Giving the vocational direction to youth for development of technical skill.
- Gainful employment in high-tech area.
- Entrepreneurial skill with techno-commercial knowledge.
- Professional ethics, work culture & personality development.
- Awareness towards the Nation, Society & Environment.

TRAINING PROGRAMMES

Wide spectrum career oriented courses being conducted are

<ul style="list-style-type: none"> • Advance Diploma Tool & Making • Diploma in Mechatronics • Certificate Course in Machinist (Tool Room) 	S.S.C. Passed
<ul style="list-style-type: none"> • Senior Tool Designer – CAD/CAM (NSQF Level-6.5) (Post Graduate Diploma in Tool Design & CAD/CAM) 	B.E. Graduates Mechanical or Equivalent
<ul style="list-style-type: none"> • Jr. Designer - CAD/CAM (NSQF Level-4.5) (Master Certificate Course in CAD/CAM) • Jr. Designer - Tool (NSQF Level-4.5) (Master Certificate Course in Tool Design) • Technical Supervisor Computer Aided Engineering (NSQF Level-5) (Master Certificate Course in Computer Aided Tool Engineering) • Technical Supervisor -Additive Manufacturing (NSQF Level-5) (Master Certificate Course in Product Design) • CNC Programmer -Tool Room (NSQF Level-4.5) (Master Certificate Course in CNC Technology) 	Degree / Diploma (Mechanical / Production / Auto Engg) Passed/ Final Year Appearing or Equivalent
<ul style="list-style-type: none"> • Artificial intelligence Application developer (NSQF LEVEL-4.5) 	Diploma (Mech. / Elec. / CS / IT or equivalent) Passed/Final Year appearing
<ul style="list-style-type: none"> • Process Designer Automation (NSQF Level-5.5) (Master Certificate Course in Automation & Process Control) 	Degree(Mech./ Prod./ Elec./ Instru. Engg) Passed / Final Year App or Equivalent
<ul style="list-style-type: none"> • Assistant Mechatronics System Designer (NSQF Level-5) (Post Diploma in Mechatronics) • Technician Machine Maintenance (Mechatronics) (NSQF Level-4.5) (Advance Certificate Course in Machine Maintenance) • Sr. Technician Mechatronics (NSQF Level-4.5) (Master Certificate Course in Mechatronics) • Sr. Technician Maintenance and Automation (NSQF Level-4.5) (Advance Diploma in Machine Maintenance & Automation) 	Degree / Diploma (Mech. / Prod. / Electrical / Electronics / Instru Engg) Pass / Final Year App or Equivalent
<ul style="list-style-type: none"> • Front Line Jr. Supervisor - Construction (NSQF Level-4.5) (Advance Diploma in Structural Design & Analysis) 	Diploma (Civil or Equivalent)Passed / Final Year App. or Equivalent
<ul style="list-style-type: none"> • Data Analysis Associate (NSQF LEVEL- 4) • Jr. Web Designer (NSQF LEVEL- 4) • Technician - Audio Video Systems (NSQF Level-4) • Technician - Room Air Conditioner & Home Appliances (NSQF Level-4) • Technician - Hand Held Products (NSQF Level-4) • CISCO Certified Network Associate (NSQF Level-4) • Technician - CNC Machining (NSQF Level-4) (Certificate Course in CNC Machining) • Technician - Computer Hardware & Network Management (NSQF Level-4) 	H.S.C. Passed
<ul style="list-style-type: none"> • Jr. Technician Tool & Die Maker (NSQF Level-3.5) (Condensed Course in Tool & Die Making) • Assistant Operator CNC Turning - Tool Room (NSQF Level-3) (Certificate Course in CNC Turning) • Assistant Operator CNC Milling - Tool Room (NSQF Level-3) (Certificate Course in CNC Milling) • Jr. Technician (Electronics Equipment) (NSQF Level-3) • Jr. Technician – Welding (NSQF Level-3) • Jr. Technician - Inspection & Quality Control (NSQF Level-3) • 3D Animator Assistant (NSQF LEVEL- 3) 	S.S.C. Passed
<ul style="list-style-type: none"> • Asst. Operator - Conventional Machines (NSQF Level-2.5) (Certificate Course in Machine Operation) 	8th Passed



SHORT TERM COURSES Skill Development Programmes in the field of CAD/CAM/CAE, Automation, General Engineering Welding for Diploma/Engineering Graduates, Professionals, Professionals of Micro, Small & Medium Enterprises

INTERNATIONAL PROGRAMMES Specific Custom Designed Training Programmes of 12 Weeks to 1 Year duration in the area of Tool Design, CAD/CAM, CNC Machining, LCA, Trainer's Training as per International customers requirement.

ENTREPRENEURSHIP SKILL DEVELOPMENT PROGRAMMES SPONSORED BY MINISTRY OF MSME Govt. of India

CAREER ORIENTED COURSES FOR SSC PASSOUTS. (SUBJECT TO ENTRANCE EXAM)

A 1. Advance Diploma in Tool & Die Making (ADTDM)

Objectives : To Design & Manufacture intricate tools like Press Tools, Plastic Moulds, Jigs Fixtures & Gauges etc. with exposure to 60 modern Die Design & Manufacturing Technology Independently

Duration : 04 years **Intake** : 120 **Course Fee** : Rs.1,92,000/-

Eligibility : 10th Std. with 60% marks in aggregate (50% for reserved category candidates)

Age : 15-19 years as on 1st August (3 years relaxation for SC / ST candidates)

A 2. Diploma in Mechatronics(DIM)

Objectives : To Provide knowledge of mechatronics system controls & skill to operate a wide variety of mechatronics equipment & controls.

Duration : 03 years **Intake** : 120 **Course Fee** : Rs.1,44,000/-

Eligibility : 10th Std. with 60% marks in aggregate (50% for reserved category candidates)

Age : 15-19 years as on 1st August (3 years relaxation for SC / ST candidates)

A 3. Certificate Course in Machinist (Tool Room) (CCMTR) NSQF LEVEL- 5

Objectives : To produce different parts of Press Tools, Plastic Moulds, Jigs, Fixtures & Gauges etc. on Conventional Tools independently with exposure to CNC Technology.

Duration : 02 years **Intake** : 40 **Course Fee** : Rs.80,000/-

Eligibility : 10th Std. with 60% marks in aggregate (50% for reserved category candidates)

Age : 15-19 years as on 1st August (3 years relaxation for SC / ST candidates)

Note: New Batch will be started from first Monday of August Every Year



CAREER ORIENTED NSQF COMPLIANT LONG / MEDIUM TERM COURSES FOR BE / B. TECH. /DIPLOMA/ITI/ SSC.

A 4. SENIOR TOOL DESIGNER – CAD/CAM (STDCC) NSQF Level: 6.5

[(POST GRADUATE DIPLOMA IN TOOL DESIGN & CAD/CAM) (PGTD&CC)]

Objective : They are Responsible for developing tool design and tool manufacturing. They will be able to generate CAD models and product design and validate the same using CAE software. And able to do the process planning and manufacturing of the product. Also, with the application of knowledge and skill of Tool and die technology and CAD/CAM/CAE, the participants can develop their own enterprises.

Duration : 1800 Hrs. **Intake** : 30 **Course Fees** : 90,000/-

Eligibility : BE Graduates (Mechanical / Prod. / Automobile or equivalent)

A 5. ASSISTANT MECHATRONICS SYSTEM DESIGNER (AMSD) NSQF Level: 5

[(POST DIPLOMA IN MECHATRONICS)(PDIM)]

Objective : To be acquainted with Mechatronics system controls. To Plan & Execute the automation solutions using PLC Programming Hydraulics & Pneumatics, SCADA.

Duration : 1200 Hrs. **Intake** : 30 **Course Fees** : 60,000/-

Eligibility : Diploma in Engineering (Mechanical / Prod. / Electrical / Electronic or equivalent)

A 6. TECHNICIAN MACHINE MAINTENANCE (MECHATRONICS) (TMMM) (NSQF LEVEL-4.5)

[ADVANCE CERTIFICATE COURSE IN MACHINE MAINTENANCE (ACMM)]

Objectives : This is a course specially designed to upgrade the Skills of ITI passed in the field of Industrial Maintenance to deal with the technological change, in which learners tend to get excellent career opportunities in the field of Machine maintenance.

Duration : 1200 Hrs. **Intake** : 30 **Course Fee** : 60,000/-

Eligibility : 2nd Year of Diploma Engg. Passed / Appeared (Mechanical / Prod. / Electrical / Electronic / Instrument)

A 7. JR.TECHNICIAN TOOL & DIE MAKER (JTDM) (NSQF LEVEL-3.5)

[(CONDENSED COURSE IN TOOL&DIE MAKING (CTDM)]

Objectives : Learners who attain this qualification are competent in Tool and Die Manufacturing and can acquire skill in Tool & Die Manufacturing with the application of machining.

Duration : 1200 Hrs. **Intake** : 30 **Course Fee** : Rs. 40,000/-

Eligibility : SSC Passed

A 8. ASST.OPERATOR –CONVENTIONAL MACHINES (AOCM) (NSQF LEVEL-2.5)

[CERTIFICATE COURSE IN MACHINE OPERATION(CCMO)]

Objectives : To acquire skill to operate conventional Machines (Lathe, Milling, Grinding, Drilling),read the drawing to produce the job on a machine, measure dimensions using linear measuring instruments

Duration : 1200 Hrs. **Intake** : 30 **Course Fee** : Rs. 60,000/-

Eligibility : 8th Passed

Note : New batches will be started from First Monday of every month
Institute reserves right to incorporate changes in course content, duration, intake capacity, no. of batches & course fee without prior notice.
Course Fees Exemption is applicable only for NSQF Compliant Long Term & Medium Term Courses for SC/ST Candidates as per the norms



Career Oriented NSQF Compliant Long / Medium Term Courses For BE/B. Tech. /Diploma/ITI/ SSC.

A 9. TECHNICAL SUPERVISOR -ADDITIVE MANUFACTURING NSQF Level: 4.5

[(MASTER CERTIFICATE COURSE IN PRODUCT DESIGN) (MCCPD)]

Objective : Qualified learner will be competent in future skills and get acquainted with product design using CAD/CAM & Additive Manufacturing

Duration : 600 Hrs.

Intake : 30

Course Fees : Rs. 35000/-

Eligibility : BE Graduates

A 10. JUNIOR DESIGNER CAD/CAM (JDCC) NSQF Level: 4.5

[(MASTER CERTIFICATE COURSE IN CAD\CAM) (MCCCC)]

Objective : To be expertise in CAD/CAM/CAE Software Application with the exposure of CNC Programming & Machining.

Duration : 600 Hrs.

Intake : 30

Course Fees : Rs. 35000/-

Eligibility : 3rd Year of Diploma Engineering Pursing /Completed (Mechanical / Prod. / Automobile or equivalent)

A 11. Jr. Designer – Tool (JDT) NSQF Level: 4.5

[(MASTER CERTIFICATE COURSE IN TOOL DESIGN) (MCCTD)]

Objective : To get acquainted with Jigs & Fixture, Press Tools, Mould Design with the application of CAD / CAM softwares

Duration : 600 Hrs.

Intake : 30

Course Fees : Rs. 35000/-

Eligibility : 3rd Year Diploma Engineering Pursing /Completed (Mechanical / Prod. / Automobile or equivalent)

A 12. Technical Supervisor - Computer Aided Engineering (TS-CAD) NSQF Level: 5

[(MASTER CERTIFICATE COURSE IN COMPUTER AIDED TOOL ENGINEERING) (MCCCATE)]

Objective : To be skill in Engineering Analysis solution through CAE Application.

Duration : 600 Hrs.

Intake : 30

Course Fees : Rs. 35000/-

Eligibility : BE Graduates (Mechanical / Prod. / Automobile or equivalent)

A 13. SR. TECHNICIAN MECHATRONICS (SRTM) (NSQF LEVEL-4.5)

[(MASTER CERTIFICATE COURSE IN MECHATRONICS) (MCCM)]

Objectives : To be acquainted with the Installation, operation of the mechatronics system. to learn the preparation and execution of logic using PLC / SCADA programming, Electrical system drawing, use and control the system using pneumatics and Hydraulic

Duration : 600 Hrs.

Intake : 30

Course Fee : Rs. 35,000/-

Eligibility : 3rd Year of Diploma Engg. (Mechanical / Prod./ Electrical / Electronic / Automobile or equivalent)

A 14. PROCESS DESIGNER – AUTOMATION (PDA) NSQF Level: 5.5

[(MASTER CERTIFICATE COURSE IN AUTOMATION & PROCESS CONTROL) (MCCAPC)]

Objective : To be acquainted with the uses of technology to improve, streamline and automate manufacturing, electricity generation, warehouse distribution, mining and many other processes to reduce the need for human intervention and maximize efficiency.

Duration : 600 Hrs.

Intake : 30

Course Fees : Rs. 35000/-

Eligibility : 3rd year of BE Pursing /Completed (Mechanical / Prod. / Automobile or equivalent)

A 15. SR. TECHNICIAN - MACHINE MAINTENANCE AND AUTOMATION (STMM) (NSQF LEVEL-4.5)

[ADVANCE DIPLOMA IN MACHINE MAINTENANCE & AUTOMATION (ADMMA)]

Objectives : To Upgrade professional skills of the learner to perform maintenance activities for Tool Room machines and equipment's.

Duration : 600 Hrs.

Intake : 30

Course Fee : Rs. 35,000/-

Eligibility : 3rd Year of Diploma Engg. (Mechanical /Instrument/Electrical or equivalent)

A 16. CNC PROGRAMMER -TOOL ROOM (CPTR) NSQF Level: 4.5

[(MASTER CERTIFICATE COURSE IN CNC TECHNOLOGY) (MCCCT)]

Objective : To acquire skills to create generate & execute CNC Programing & Operation

Duration : 600 Hrs.

Intake : 30

Course Fees : Rs. 35000/-

Eligibility : 3rd year of Diploma Engg. (Mechanical / Prod. / Automobile or equivalent)

A 17. Front Line Junior Supervisor (Construction) (FLJSC) NSQF Level: 4.5

[(ADVANCE DIPLOMA IN STRUCTURAL DESIGN & ANALYSIS)(ADSDA)]

Objective : To acquire Skill to work in Auto CAD, STAAD PRO, 3D Studio MAX, REVIT Architecture, Total station, Auto Level, GPS to work in construction sector

Duration : 600 Hrs.

Intake : 30

Course Fees : Rs. 35000/-

Eligibility : Diploma Engg .(Civil Engg. or equivalent)

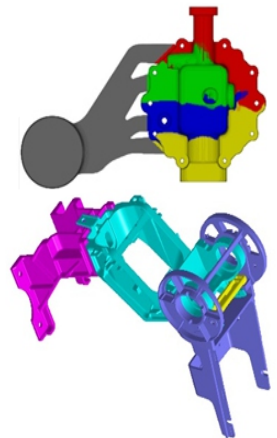

CAREER ORIENTED NSQF COMPLIANT LONG / MEDIUM TERM COURSES FOR BE/B. TECH. /DIPLOMA/ITI/ SSC.

A.18. TECHNICIAN -CNC MACHINING (NSQF Level: 4)

[(CERTIFICATE COURSE IN CNC MACHINING) (CCCM)]

Objective : To learn to perform Machine setup , Job setup and operate the machine. Perform tool Setting as per job requirement Set machining parameters as per the requirement of job.

Duration : 600 Hrs. **Intake** : 30 **Course Fees** : Rs. 35000/-

Eligibility : HSC Passed

A.19. ASSISTANT OPERATOR- CNC TURNING -TOOL ROOM (AOCTTR) (NSQF LEVEL 3)

[CERTIFICATE COURSE IN CNC TURNING(CCCT)]

Objectives : To be expertise in CNC Lathe operating cum setting.

Duration : 600 Hrs. **Intake** : 30 **Course Fee** : Rs. 35,000/-

Eligibility : SSC Passed

A.20. ASST. OPERATOR - CNC MILLING (TOOL ROOM) (AOCMTR) (NSQF LEVEL 3)

[CERTIFICATE COURSE IN CNC MILLING (CCCM)]

Objectives : To be expertise in operating cum setting of CNC Milling Machine

Duration : 600 Hrs. **Intake** : 30 **Course Fee** : Rs. 35,000/-

Eligibility : SSC Passed



A.21. JR. TECHNICIAN – WELDING (NSQF LEVEL- 3)

Objective : To Understand the various welding methods & perform welding operation on different materials with selection of appropriate welding methods read basic engineering drawings for welding operation

Duration : 600 Hrs. **Intake:** 30 **Course Fee:** Rs 35,000/-

Eligibility : SSC Passed

A.22. JR. TECHNICIAN – INSPECTION & QUALITY CONTROL (NSQF LEVEL- 3)

Objective : To acquire skill in Checking & inspection of parts & quality control get competency in Inspection and Quality Control

Duration : 600 Hrs. **Intake:** 30 **Course Fee:** Rs. 35,000/-

Eligibility : SSC Passed

A.23. JR. Technician – (Electronics Equipment) (NSQF Level- 3)

Objective : To acquire skill in electronic gadgets repairing & maintenance

Duration : 600 Hrs. **Intake:** 30 **Course Fee** : Rs. 35,000/-

Eligibility : SSC Passed

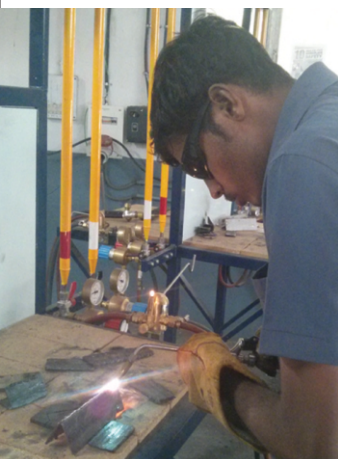

A.24. TECHNICIAN- AUDIO VIDEO SYSTEMS (NSQF LEVEL-4)

Objectives : To acquire skill in Installation, repairing & servicing of CRT TV, LCD TV, LEDTV, PLASMA TV, SMART TV, DVD PLAYER and HOME AUDIO

Duration : 510 Hrs. **Intake** : 30 **Course Fee** : Rs. 30,000/-

Eligibility : HSC Passed

A.25. TECHNICIAN – ROOM AIR CONDITIONER & HOME APPLIANCES (NSQF LEVEL- 4)

Objective : To learn about Installation, repairing & servicing of AC/Refrigerator/Washing Machine & Microwave Oven, Refrigeration and Air Conditioner Mechanic in domestic, ice factory, cold storage plants, specialized air conditioning units or Refrigeration, Air Conditioner industries.

Duration : 600 Hrs. **Intake:** 30 **Course Fee** : Rs. 35,000/-

Eligibility : HSC Passed



Note : New batches will be started from First Monday of every month

Institute reserves right to incorporate changes in course content, duration, intake capacity, no. of batches & course fee without prior notice.
Course Fees Exemption is applicable only for NSQF Compliant Long Term & Medium Term Courses for SC/ST Candidates as per the norms

A. LONG & MEDIUM TERM COURSES

CAREER ORIENTED NSQF COMPLIANT LONG / MEDIUM TERM COURSES FOR BE/B. TECH. /DIPLOMA/ITI/ SSC.

A 26. TECHNICIAN - HAND HELD PRODUCTS (NSQF LEVEL 4)

Objectives : To learn to rectify the faults in the Hand Held Products like Mobile, Tablet, Laptop. by performing front end or hardware level repair as required, resolves software issues and ensures effective functioning before delivering back to customer.

Duration : 510 Hrs. **Intake** : 30 **Course Fee** : Rs. 30,000/-

Eligibility : HSC Passed



A 27. CISCO CERTIFIED NETWORK ASSOCIATE (NSQF LEVEL-4)

Objectives : To get acquainted with Computer Networks, various protocols used in Communication, Managing and configuring Cisco Switches and Routers and various WAN technologies. Manage Network for an Organization. Install, configure, operate, and troubleshoot medium -sized routed and switched networks.

Duration : 480 Hrs. **Intake**: 30 **Course Fee** : Rs. 30,000/-

Eligibility : HSC Passed

A 28. TECHNICIAN – COMPUTER HARDWARE AND NETWORK MANAGEMENT (NSQF LEVEL- 4)

Objective : To get acquainted with the maintenance & troubleshooting of computer hardware & Networking Assemble & disassemble the computer as well as Install various types of software and fault tolerant solutions, Setup server network and share the data, Manage various operating system

Duration : 600 Hrs. **Intake**: 30 **Course Fee** : Rs. 35,000/-

Eligibility : HSC Passed

A 29. ARTIFICIAL INTELLIGENCE APPLICATION DEVELOPER (NSQF LEVEL-4.5)

Objective : To acquire skill in Python programming and libraries like Numpy and pandas used for data analysis, Visualization with Matplotlib with the concepts of Machine Learning.

Duration : 540 Hrs. **Intake** : 30 **Course Fee** : Rs. 30,000/-

Eligibility : 3rd Year of Diploma Appeared / Passed (Mechanical / Electrical / Electronics / CS / IT or equivalent)

A 30. DATA ANALYSIS ASSOCIATE (NSQF LEVEL- 4)

Objective : To get basic skills of data handling, processing and visualization, viewing data in summary and aggregated form, formulate equation for prediction. Hadoop Framework and programming experience of core Java.

Duration : 450 Hrs. **Intake** : 30 **Course Fee** : Rs. 26,000/-

Eligibility : HSC Passed

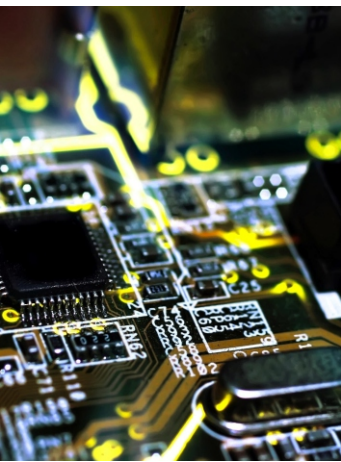

A 31. JR. WEB DESIGNER (NSQF LEVEL- 4)

Objectives : To acquire skill in Creation and managing content for websites USING web technologies such as HTML, CSS, and JavaScript for front-end development.

Duration : 390 Hrs. **Intake** : 25 **Course Fee** : Rs. 24,000/-

Eligibility : HSC Passed

A 32. 3D ANIMATOR ASSISTANT (NSQF LEVEL- 3)

Objective : To get skills to Create Visual Design in 3D software, Add Texturing, Lighting & Rendering process in created models, Character Animation, Edit the created animation video clip

Duration : 600 Hrs. **Intake** : 25 **Course Fee** : Rs. 35,000/-

Eligibility : SSC Passed

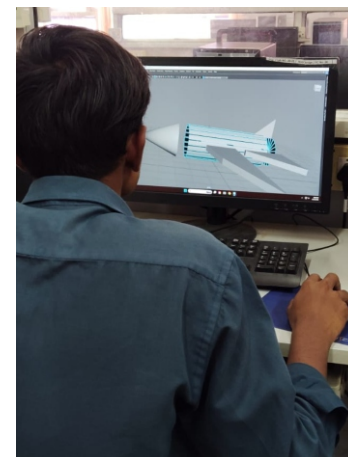

Note : New batches will be started from First Monday of every month

Institute reserves right to incorporate changes in course content, duration, intake capacity, no. of batches & course fee without prior notice.
Course Fees Exemption is applicable only for NSQF Compliant Long Term & Medium Term Courses for SC/ST Candidates as per the norms

CAREER ORIENTED LONG TERM COURSES FOR BE / DIPLOMA / ITI / SSC (NON-NSQF)

B1. Post Graduate Diploma in Mechatronics (PGDIM)

Objectives : To be acquainted with Mechatronics system controls. To be able to execute the automation solutions using PLC Programming, Hydraulics & Pneumatics, SCADA.
Duration : 18 Months **Intake:** 30 **Course Fee:** Rs 90,000/-
Eligibility : Degree in Engineering (Mechanical / Electrical / Electronics / E&TC / Instrumentation) or Equivalent.

B2. Post Diploma in Tool Design & CAD/CAM (PDTD&CC)

Objectives : To be acquainted with modern Tool Design & CAD/CAM Technology To plan and execute the Design of Press Tools Jigs & Fixtures, etc. Using Computer Aided Design, with Knowledge of Computer Aided Manufacturing, CNC Programming & Machining
Duration : 12 Months **Intake:** 30 **Course Fee:** Rs 60,000/-
Eligibility : Diploma in Engineering (Mech./Prod./Automobile).

B3. Post Diploma in Tool & Die Manufacturing (PDTDM)

Objectives : To be acquainted with modern Tool & Die Manufacturing Technology. To plan and execute the Programming & Machining Practices
Duration : 12 months **Intake :**30 **Course Fee:** Rs 60,000/-
Eligibility : Diploma in Engineering (Mech./Prod./Automobile).

B4. Post Diploma in Computer Aided Engineering (PDCAE)

Objectives : To be acquainted with modern Tool Engineering Technology. To plan and execute the Manufacturing of Tool & Dies using latest Computer Aided Design, Computer Aided Manufacturing, CNC Programming & Machining Practices
Duration : 12 Months **Intake:**30 **Course Fee:** Rs 60,000/-
Eligibility : Diploma in Engineering (Mech./Prod./Automobile) of Equivalent.



B5. Post Diploma in Product Design (PDPD)

Objectives : To be acquainted with Product Design Techniques. To plan and execute the Product Design using CAD/CAM & Additive Manufacturing
Duration : 12 Months **Intake** 30 **Course Fee** Rs 60,000
Eligibility : Degree/Diploma in Engineering (Mech./Prod./Automobile) or Equivalent.

B6. Post Diploma in CNC Machine Maintenance (PDCNCMM)

Objectives : To be acquainted with modern day Machine Maintenance Techniques. To plan & Execute the Maintenance automation solutions using PLC Programming, SCADA, Hydraulics & Pneumatics & other Mechatronics system controls of the CNC Machine & their Maintenance schedules.
Duration : 12 Months **Intake :**30 **Course Fee:** Rs 60,000
Eligibility : Diploma in Engineering (Mech/Elec./ESTC/Instrumentation) or Equivalent.

B7. Post Diploma in VLSI & Embedded Systems (PDVLSI)

Objective : To be acquainted with ASIC Design and Verification, Embedded Design system To plan & Design solutions for small size, high speed, high performance computational applications using VLSI & Embedded circuits.
Duration : 12 Months **Intake:** 30 **Course Fee:** Rs. 60,000/-
Eligibility : Diploma in Engineering (Mech./Elec./ETC/Instrumentation) or Equivalent.

B8. Post Diploma in Industrial Automation/Robotics (PDIA/R)

Objectives: To be acquainted with modern day Industrial Automation Techniques. To plan & execute the Industrial Automation & Robotics application using Mechatronics System control
Duration : 12 Months **Intake** 30 **Course Fee:** Rs. 60,000/-
Eligibility : Diploma in Engineering (Mech./Elec./ETC/Instrumentation) or Equivalent.

B9. Advance Certificate Course in Tool Design & CAD/CAM (ACCTD&CC)

Objectives : To be acquainted with modern Tool Design & CAD/CAM Technology. To plan and execute the Design of Press Tools Jigs & Fixtures, etc. Using Computer Aided Design, Computer Aided Manufacturing, CNC Programming & Machining.
Duration : 12 Months **Intake:** 30 **Course Fee:** Rs. 50,000/-
Eligibility : I.T.I. (Machinist/Turner/Bench Fitter/Tool & Die Maker/Draftsman Mech.).



Note : New batches will be started from First Monday of every month
 Institute reserves right to incorporate changes in course content, duration, intake capacity, no. of batches & course fee without prior notice.
 Course Fees Exemption is applicable only for NSQF Compliant Long Term & Medium Term Courses for SC/ST Candidates as per the norms

B. LONG & MEDIUM TERM COURSES (NON NSQF)

CAREER ORIENTED LONG TERM COURSES FOR BE / DIPLOMA / ITI / SSC (NON-NSQF)

B 10. Advance Certificate Course in Tool & Die Manufacturing (ACCTDM)

Objectives: To be acquainted with modern Tool & Die Manufacturing Technology. To plan and execute the Manufacturing of Tool & Dies using latest Computer Aided Design, Computer Aided Manufacturing, CNC Programming & Machining Practices.

Duration : 12 Month **Intake:** 30 **Course Fee:** Rs.50,000/-
Eligibility : I.T.I. (Machinist/Turner/Bench Fitter/Tool & Die Maker)

B 11. Advance Certificate Course in CNC Machining (ACCCM)

Objectives : To be acquainted with CNC Machining Techniques using Latest CNC Machining Technology. To Program & Handle CNC Machines (Lathe, Milling, Wire-cut & EDM) - live Projects.

Duration : 12 Months **Intake:** 30 **Course Fee** : Rs. 50,000/-
Eligibility : I.T.I. (Machinist / Turner / Bench Fitter / Tool & Die Maker / Grinder)

B 12. Advance Certificate Course in Machine Maintenance (ACCM)

Objectives : To be acquainted with CNC Machine Maintenance (Mechanical, Electrical, Electronics) with live projects on CNC Machine & Conventional Maintenance.

Duration : 12 Months **Intake:** 30 **Course Fee:** Rs. 50,000/-
Eligibility : I.T.I. (Machinist / Turner / Electrician / Tool & Die Maker / Electronics / MMTM / MMTR)

B 13. Advance Certificate Course in Welding Technology (ACCWT)

Objectives : To be acquainted with Advance Welding techniques with live projects on Arc Welding, Gas Welding, MIG / MAG Welding, TIG Welding.

Duration : 12 Months **Intake:** 30 **Course Fee:** Rs. 50,000/-
Eligibility : I.T.I. (Turner / Fitter / Machinist / Welder)



B 14. Certificate Course in CNC Turning & Milling (CCCTM)

Objectives : To be acquainted with Manufacturing Elements of Press Tools, Plastic Moulds, Jigs, Fixtures & Gauges, Die Casting Dies, etc. Using CNC Technology.

Duration : 12 Months **Intake:** 30 **Course Fee:** Rs. 40,000/-
Eligibility : 10th Pass.

B 15. Certificate Course in Machine Tool Operations & Welding Operations (CCMT&WO)

Objectives : To be acquainted with Conventional Machine Operations & Basic Welding Operations like Gas Welding & Arc Welding.

Duration : 12 Months **Intake:** 30 **Course Fee:** Rs. 35,000/-
Eligibility : 10th Appeared

B 16. Certificate Course in Machine Maintenance & Welding Operations (CCMM&WO)

Objectives : To be acquainted with Conventional Machine (Mechanical) & Basic Welding Operations like Gas Welding & Arc Welding.

Duration : 12 Months **Intake:** 30 **Course Fee:** Rs. 35,000/-
Eligibility : 10th Appeared



CARRIER ORIENTED MEDIUM-TERM COURSES FOR BE / DIPLOMA / ITI / 10TH (NON-NSQF)

B.17. Master Certificate Course in Welding Operation

- Advance Welding Technology
- Arc Welding, Gas Welding
- MIG / MAG Welding, TIG Welding
- Entrepreneurship, Course - Work: Project

Duration: 24 weeks (8 hrs. / day)

Course Fees: Rs. 35,000/-



Note : New batches will be started from First Monday of every month
 Institute reserves right to incorporate changes in course content, duration, intake capacity, no. of batches & course fee without prior notice.
 Course Fees Exemption is applicable only for NSQF Compliant Long Term & Medium Term Courses for SC/ST Candidates as per the norms

B.3 : For BE / DIPLOMA / ITI (Part Time Courses for Industrial Professionals only)

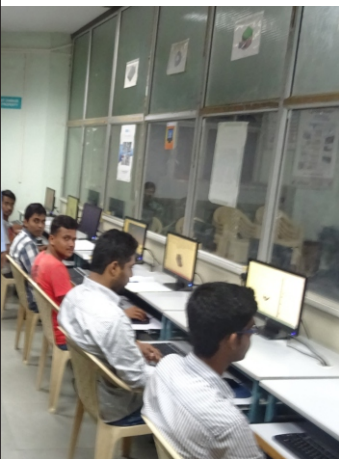

B.3 a Certificate Course in Mechatronics

- Applied Pneumatics
- Applied Hydraulics
- PLC Programming
- Mechatronics Technology
- Project Work

Duration : 24 Weeks (4 hrs / day)
Course Fees : Rs. 25,000/-

B.3 b Certificate Course in VLSI And Embedded System Design

- Dsch, CMOS Design, Layout Design(µ wind 3)
- VHDL, XILINX, VERILOG, PLD(FPGA & CPLD)
- Embedded System, 'C'language, 8051
- PIC & ARM7(LPC 2148) Microcontroller
- Project Work

Duration : 24 Weeks (4 hrs / day)
Course Fees :Rs. 25,000/-

B.3 c Certificate Course in Tool Design & CAD/CAM

- Auto CAD, Master CAM,
- Catia(CAD), UG (CAD/CAM)
- Design of Jigs and Fixtures,
- Press Tools, Moulds, Die Casting Dies
- CNC Programming
- Project Work

Duration : 48 weeks (4 hrs / day)
Course Fees : Rs. 25,000/-

B.3 d Certificate Course in 3D Printing & Reverse Engineering

- Auto CAD
- Solid Works
- 3D Printing
- 3D Scanning
- Project Work

Duration : 24 weeks (4 hrs / day)
Course Fees : Rs. 25,000/-

B.3 e Certificate Course in Tool Design

- Auto CAD
- Design of Jigs and Fixtures
- Design of Press Tools
- Design of Moulds
- Design of Die Casting Dies
- Project Work

Duration : 24 weeks (4 hrs / day)
Course Fees : Rs. 25,000/-

B.3 f Certificate Course in CAD/CAM

- Auto CAD, Catia(CAD)
- Master CAM(CAD/CAM)
- UG(CAD/CAM)
- CNC Programming
- Project Work

Duration : 24 weeks (4 hrs / day)
Course Fees : Rs. 25,000/-

B.3 g Certificate Course in Autotronics

- Automotive Electrical & Starting System
- Fuel System & Engine Control
- Structural Part
- Safety & Associated Systems

Duration : 24 weeks (4 hrs / day)
Course Fees : Rs. 25,000/-

B.4 : For 12th Passout / B.Sc. Graduates / ITI (Appeared)

B.4 a Advance Certificate Course in Inspection & Quality Assurance

- Engineering Drawing , Engineering Metrology
- CAD (Auto CAD & Unigraphics NX), Workshop Calculation
- Total Quality Management, Inspection (CMM), Project

Duration : 24 Weeks (8 hrs / day)
Course Fees : Rs. 25,000/-



B.5 : For SSC Passout

B.5 a Certificate Course in Mach. Oper. - Lathe

- W/S. Tech., Blue Print Reading
- Engg. Metrology.
- CNC Prog./ Macg. (Wire Cut & EDM)
- Live Projects - CNC Machining

Duration : 24 Weeks (8 hrs / day)
Course Fees : Rs. 20, 000/-

B.5 b Certificate Course in Mach. Oper. - Milling

- W/S. Tech., Blue Print Reading
- Engg. Metrology.
- CNC Prog./ Macg. (Wire Cut & EDM)
- Live Projects - CNC Machining.

Duration : 24 Weeks (8 hrs / day)
Course Fees : Rs. 20, 000/-

B.5 c Certificate Course in Mach. Oper. - WIRE CUT & EDM

- W/S. Tech., Blue Print Reading
- Engg. Metrology.
- W/S Pract. (Lathe & Milling)
- CNC Prog./ Macg. (Wire Cut & EDM)
- Live Projects - CNC Macg.

Duration : 24 Weeks (8 hrs / day)
Course Fees : Rs. 20, 000/-

Note : New batches will be started from First Monday of every month
Institute reserves right to incorporate changes in course content, duration, intake capacity, no. of batches & course fee without prior notice.
Course Fees Exemption is applicable only for NSQF Compliant Long Term & Medium Term Courses for SC/ST Candidates as per the norms

C. SHORT TERM COURSES

For Students / Institutes Professionals & Industrial Professionals

C.1 CAD / CAM / CAE (Mechanical / Production / Automobile Engineering or Equivalent)

C.1 a Auto CAD (Mech)

- Creating Objects
- Editing Objects
- Layers, Colours & Line Types
- Dimensioning & Tolerancing
- Blocks, Attributes & X - REF
- Layout, Plotting & Priting
- 3D Modeling

Duration : 96 Hrs (4 weeks, 4 hrs / day)
Course Fees : Rs. 4,500/-

C.1 b Collab CAD

- Sketcher
- Part Design
- Surfacing
- Drafting
- Assembly
- 3D Modelling
- CAM Machining

Duration : 72 Hrs (3 weeks, 4 hrs / day)
Course Fees : Rs. 4,500/-

C.1 c Solidworks (CAD)

- Sketcher
- Part Design
- Surfacing
- Drafting
- Assembly
- Simulation

Duration : 96 Hrs (4 weeks, 4 hrs / day)
Course Fees : Rs. 5,500/-

C.1 d Unigraphics (CAD)

- Introduction
- Interface & Coordinate System
- Curves
- Sketcher
- Featured Based Modeling
- Assembly & Details
- Drafting
- Free Form Features

Duration : 96 Hrs (4 weeks, 4 hrs / day)
Course Fees : Rs. 8,000/-

C.1 e Unigraphics (CAM)

- Introduction
- Overview of Mfg. Applications
- Point To point Machining
- Planner Turning & Milling
- Cavity Milling
- Prog. Generation & Transfer to M/C

Duration : 96 Hrs (4 weeks, 4 hrs / day)
Course Fees : Rs. 8,000/-

C.1 f Catia (CAD)

- Introduction to CATIA
- Sketcher Workbench
- Part Design Workbench
- Wire Frame & Surface Design
- Assembly Design Workbench
- Generative & Interactive Drafting

Duration : 96 Hrs (4 weeks, 4 hrs / day)
Course Fees : Rs. 8,000/-

C.1g Creo Parametric (CAD)

- Introduction to CREO PARAMETRIC
- Fundamentals of CREO PARAMETRIC
- Sketcher
- Part Modeling
- Pro Surface
- Assembly Modeling
- Detailing

Duration : 96 Hrs (4 weeks, 4 hrs / day)
Course Fees : Rs. 8,000/-

C.1h Master CAM (CAD / CAM)

- 2D Drafting
- Wire Frame Modeling
- Surface Modeling
- Tool Path Generation
- Transfer to Machine
- Post Processing

Duration : 96 Hrs (4 weeks, 4hrs / day)
Course Fees : Rs. 5,500/-

C.1 I Cimatron (CAD)

- Sketcher
- Navigation, Datum, Analyze and file management.
- Part (Curves, Faces and Solid) Design
- Assembly Design
- Catalogs
- Drafting (Part and Assembly)

Duration : .72 Hrs (3 weeks, 4hrs / day)
Course Fees : Rs. 8,000/-

C.1j Delcam (CAD / CAM)

- 2D Drafting
- Wire Frame Modeling
- Surface Modeling
- Tool Path Generation
- Transfer To Machine / Post Processing

Duration : 96 Hrs. (4 weeks, 4 hrs / day)
Course Fees : Rs. 5,500/-

C.1 k Delcam - 5 Axis Machining

- 2D Drafting
- Wire Frame Modeling
- Surface Modeling
- Tool Path Generation (5 Axis Machining)
- Transfer To Machine / Post Processing

Duration : 96 Hrs. (4 weeks, 4 hrs / day)
Course Fees : Rs. 8,000/-

C.1 l Delcam Art CAM

- Introduction to Art CAM
- Art CAM Pro Design
- 2D Vector Design
- 3D Design
- Profile Generation
- Machining

Duration : 72 Hrs (3 weeks, 4hrs / day)
Course Fees : Rs. 8,000/-

C.1 m Ansys

- Introduction to FEA
- Ansys Basics
- Different types of Interfaces
- Structural Analysis
- Thermal Analysis
- Model Analysis

Duration : 96 Hrs (4 weeks, 4hrs / day)
Course Fees : Rs. 8,000/-

C.1 n Ansys (CFD)

- Introduction to CFD, CFX & FLUENT,
- Design Modeler, Meshing, Turbulent Models,
- Boundary Condition Specifications
- Solver Solution Methods & Hydrodynamic,
- Aerodynamic, Heat Transfer / Thermal Analysis
- Int. & Ext. Flows, Post-Processing / Results

Duration : 72 Hrs (3 weeks, 4hrs / day)
Course Fees : Rs. 8,000/-

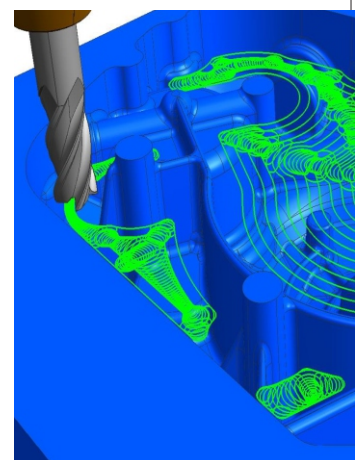
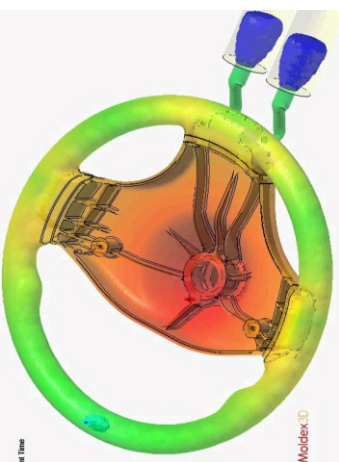

Note : New batches will be started from First Every Monday of every month

Institute reserves right to incorporate changes in course content, duration, intake capacity, no. of batches & course fee without prior notice.
Course Fees Exemption is applicable only for NSQF Exempted short Term Courses for SC/ST Candidates as per the norms

C.1 CAD / CAM / CAE (Mechanical / Production / Automobile Engineering or Equivalent)

C.1 o Hypermesh (CAE)

- Introduction to FEA, Hypermesh
- Geometry Creation
- 2D Meshing, 3D Meshing
- Mesh Analysis
- Optistruct
- Introduction to Hyperform / Hyper - View

Duration : 96 Hrs (4 weeks, 4hrs / day)
Course Fees : Rs. 8,000/-

C.1 p Moldex - 3D (CAE)

- Introduction & History of CAE
- Import cavity
- Building runner system model
- Meshing feed system
- Creating Molding Process & Analysis
- Flow Pack, Warp, Cooling Results

Duration : .72 Hrs (3 weeks, 4hrs / day)
Course Fees : Rs. 8,000/-

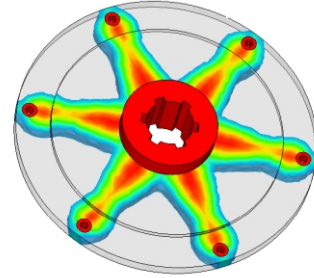

C.1 q Hyperform (CAE)

- Introduction to FEA, Hypermesh
- Geometry Creation
- One Step Analysis
- Incremental
- Visualization by Hyperview
- Solving through Radioss Solver

Duration : 72 Hrs (3 weeks, 4hrs / day)
Course Fees : Rs. 9,000/-

C.1 r Product Design

- Fundamentals of Design, Sketching & Optimizing
- Preparing CAD Geometry, Minimizing Mass
- Running a Baseline Analysis, Simplifying Geometry
- Additive Manufacturing Technology
- Fundamentals of Additive Mfg. & Application

Duration : .72 Hrs (3 weeks, 4hrs / day)
Course Fees : Rs. 10,000/-

C.2. CAD/CAE (Civil Engineering / Architectural Engineering)

C.2 a Auto CAD (Civil)

- Creating Objects
- Editing Objects
- Layers, Colours & Line Types
- Dimensioning & Tolerancing
- Blocks, Attributes & X - REF
- Layout, Plotting & Printing
- Working in 3D Space

Duration : 96 Hrs (4 weeks, 4 hrs / day)
Course Fees : Rs. 4,500/-

C.2 b Staad Pro

- Introduction To Staad Pro
- Analysis of Rc Structure & Power Transmission Tower
- Application of Loading Condition
- Method For Designing Shear Wall
- Design of Slab

Duration : 96 Hrs (4 weeks, 4 hrs / day)
Course Fees : Rs. 8,000/-

C.2 c Revit Architecture

- Revit Auto Desk Architecture
- Getting Started Principles And Concepts
- Working With Project And Elements
- Working With Projects Views And Work Planes
- Working With Basic Building Components
- Working With Site Design
- Working With Construction Documents

Duration : 96 Hrs (4 weeks, 4 hrs / day)
Course Fees : Rs. 8,000/-

C.2 d 3DS Max

- Introduction of 3ds Max
- Getting Started (principle & Concept)
- Creating objects of Layer And Walls
- Working With Primitives Modifiers & Reactors In 3ds Max
- Modeling In 3ds Max
- Basics of Lights And Materials And Camera
- Animation of 3ds Max, Exploring Rendering
- Creating Surface Model

Duration : 96 Hrs (4 weeks, 4 hrs / day)
Course Fees : Rs. 8,000/-

C.2 e Civil Survey Using Total Station

- Introduction
- Station Setup
- Stake Out
- Program
- Data Downloading

Duration : 72 Hrs (3 weeks, 4 hrs / day)
Course Fees : Rs. 7,000/-

C.3 CNC Programming / CNC Machining (Mechanical / Production / Automobile Engineering or Equivalent)

C.3 a CNC Programming - Lathe (ISO/FANUC/SINUMERIK)

- Introduction to CNC Tech.
- Geo. Basics for CNC M/c
- Tech. I Basics for CNC M/c
- CNC Programming

Duration : 96 Hrs (4 weeks, 4 hrs / day)
Course Fees : Rs. 6,500/-

C.3 b CNC Programming - Milling (ISO/FANUC/SINUMERIK/HADENHEIN)

- Introduction to CNC Tech.
- Geo. Basics for CNC M/c
- Tech. Basics for CNC M/c
- CNC Programming

Duration : 96 Hrs (4 weeks, 4 hrs / day)
Course Fees : Rs. 6,500/-



Note : New batches will be started from First Every Monday of every month

Institute reserves right to incorporate changes in course content, duration, intake capacity, no. of batches & course fee without prior notice.
 Course Fees Exemption is applicable only for NSQF Exempted short Term Courses for SC/ST Candidates as per the norms

C. SHORT TERM COURSES

C.3 CNC Programming / CNC Machining (Mechanical / Production / Automobile Engineering or Equivalent)

C.3 c CNC Machining - Lathe

- Preparation of Part Geometry
- Preparing & Setting for Operation
- Setup of Zero Pt. Displacement
- Tool Offset Values
- Optimizing Tool Path
- Execution of Part Program

Duration : 96 Hrs (4 weeks, 4 hrs / day)
Course Fees : Rs. 8,000/-

C.3 e CNC Machining - Wire-cut

- Programming of the Part Program
- Preparation Tech. for Operation
- Setting up of WEDM Machine
- Simulation with Dry Run
- Execution of the part program

Duration : 72 Hrs. (3 weeks, 4 hrs / day)
Course Fees : Rs. 8,000/-

C.3 d CNC Machining - Milling

- Programming for CNC Milling
- Preparing & Setting for Operation
- Setup of Tools
- Radial & Axial Offset Values
- Test Run Simulation
- Execution of the Part Program

Duration : 96 Hrs (4 weeks, 4 hrs / day)
Course Fees : Rs. 8,000/-

C.3 f CNC Machining - EDM

- Prog. of the Part Program
- Preparation Tech. for Operation
- Setting up of EDM Machine
- Simulation with Dry Run
- Execution of the part program

Duration : 72 Hrs. (3 weeks, 4 hrs / day)
Course Fees : Rs. 8,000/-



C.4 TOOL DESIGN (Mechanical / Production / Automobile Engineering or Equivalent)

C.4 a Press Tool Design using Cimatron

- Blank Dev. Simple to complex parts
- Transfer and Progressive Nesting
- Compound Tool Design
- Progressive 3D Tool Design
- Motion Analysis, BOM and Drafting (Part and Assembly)

Duration : 72 Hrs (3 weeks, 4 hrs / day)
Course Fees : Rs. 11,000/-

C.4 b Moulds Design using Cimatron

- Core Cavity Extraction
- Inserts management
- Electrode management
- 3D Mould Design
- Motion Analysis, BOM and Drafting (Part & Assembly)

Duration : 72 Hrs (3 weeks, 4 hrs / day)
Course Fees : Rs. 11,000/-

C.4 c Die Casting Dies using Cimatron

- Cover and Ejector Die design
- Electrode management
- 3D Die Casting Die
- Motion Analysis, BOM & Drafting (Part and Assembly)

Duration : 72 Hrs. (3 weeks, 4 hrs / day)
Course Fees : Rs. 11,000/-

C.4 d Design of Jigs & Fixtures

- Introduction
- Elements & Their Function
- Jigs & Fixtures & Their Classification
- Tool Design Parameters
- Design of Jigs & Fixtures
- Materials For Jigs & Fixtures Elements

Duration : 48 Hrs. (2 weeks, 4 hrs / day)
Course Fees : Rs. 8,000/-

C.4 e Design of Gauges

- Introduction
- Elements & Their Classification
- Gauges & Their Classification
- Tool Design Parameters
- Design of Gauges
- Materials for Gauge Elements

Duration : 48 Hrs (2 weeks, 4 hrs / day)
Course Fees : Rs. 8,000/-

C.4 f Design of Cutting Tools

- Introduction
- Tool Geometry
- Metal Cutting Theory
- Design of Cutting Tools
- Materials For Cutting Tools

Duration : 48 Hrs (2 weeks, 4 hrs / day)
Course Fees : Rs. 8,000/-

C.4 g Press Tool Design & Simulation using Hyperform

- Introduction to Press Tool
- Elements & their functions
- Press Tool Operation & Classification
- Design Parameters
- Introduction to Hypermesh & Hyperform
- Hyperform Solver
- Simulation using Optristruct

Duration : 72 Hrs (3 weeks, 4 hrs / day)
Course Fees : Rs. 11,000/-

C.4 h Mould Design & Simulation Using MOLDEX-3D

- Introduction & History of CAE
- Import Model
- Building feed system using Adviser
- Building Cooling system
- CFCPW
- Flow pack, Warp, Cooling Results

Duration : .72 Hrs (3 weeks, 4 hrs / day)
Course Fees : Rs. 10,000/-

C.4 i Casting with ADSTEFAN

- Introduction to Die Casting Design
- Elements & their functions
- Die Casting Operation & Classification
- Design Parameters
- Minimizing Defects
- Design Improvement
- Cost Reduction

Duration : 72 Hrs (3 weeks, 4 hrs / day)
Course Fees : Rs. 10,000/-

C.4 j Advance Mould Design & Simulation Using MOLDEX - 3D

- Introduction & History of CAE
- Hot Runner Injection Mould
- MCM-Multi Component Moulding
- Metallic Inserts Moulding
- CFCPW
- Flow pack, Warp, Cooling Results

Duration : .72 Hrs (3 weeks, 4 hrs / day)
Course Fees : Rs. 10,000/-

C.5 GENERAL ENGINEERING (Mechanical / Production / Automobile Engineering or Equivalent)

C.5 a Geometric Dim. & Tolerances

- Introduction to G D & T
- G D & T Symbols & Ind. App.
- Classification.
- Concept of Limits, Fits & Tolerances.
- App. of Limits, Fits & Tolerances.

Duration : 24 Hrs (1 week, 4 hrs / day)
Course Fees : Rs. 4,500/-

C.5 b Metrology

- Introduction to Metrology
- Measurement - Equipment & Technique
- Linear, Angular, Profile
- Advance Measurement
- Practice On Measurement.

Duration : 24 Hrs (1 week, 4 hrs / day)

C.5 c Basic Course in CMM

- Introduction
- Principle of Working
- Application & use

Duration : 24 Hrs
(1 week, 4 hrs / day)
Course Fees : Rs. 7,000/-

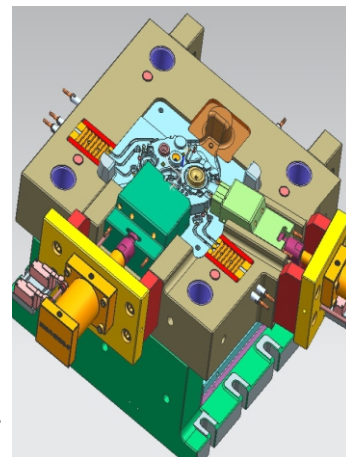

Note : New batches will be started from First Every Monday of every month
Institute reserves right to incorporate changes in course content, duration, intake capacity, no. of batches & course fee without prior notice.
Course Fees Exemption is applicable only for NSQF Exempted short Term Courses for SC/ST Candidates as per the norms

C.6 AUTOMATION

(Electrical / Electronics / Instrumentation / Computer / Mechanical or equivalent B.Sc. / M.Sc. Electronics / Computer Science)



C.6 a Basic Pneumatics

- Introduction
 - Fundamental Principles
 - Energy Supply Elements
 - Directional Control Valves
 - Circuit Design & Application
- Duration : 24 Hrs (1 week, 4 hrs / day)**
Course Fees : Rs. 3,500/-

C.6 b Basic Hydraulics

- Introduction
 - Fundamental Principles
 - Energy Supply elements
 - Directional Control Valves
 - Circuit Design & Application
- Duration : 24 Hrs (1 week, 4 hrs / day)**
Course Fees : Rs. 3,500/-

C.6 c Electro Pneumatics

- Introduction
 - Fundamental Principles
 - Energy Supply Elements
 - Directional Control Valves
 - Circuit Design & Application
- Duration : 24 Hrs (1 week, 4 hrs / day)**
Course Fees : Rs. 4,500/-

C.6 d Electro Hydraulics

- Introduction
 - Fundamental Principles
 - Energy Supply Elements
 - Directional Control Valves
 - Circuit Design & Application
- Duration : 24 Hrs (1 week, 4 hrs / day)**
Course Fees : Rs. 4,500/-

C.6 e Electrical Cad (e Cad)

- Autocad & Co-ordinate System
 - Array, Mirror, Copy, move
 - Inserting Components
 - Wire & Ladders, Trim, Parent-child Comp.
 - Multiple Wire Bus & Edit Component
 - Component Alignment, Attributes, Scoot, Move
- Duration : 96 Hrs (4 weeks, 4 hrs / day)**
Course Fees : Rs. 4,500/-

C.6 f Advance Pneumatics

- Introduction
 - Fundamental Principles
 - Energy Supply Elements
 - Directional Control Valves
 - Fundamentals of Control Engg.
 - Circuit Design & Application
- Duration : 24 Hrs (1 week, 4 hrs / day)**
Course Fees : Rs. 5,500/-

C.6 g PLC Programming

- Introduction of Ind. Automation
 - Details of PLC Hardware (SIEMENS)
 - Programming Languages
 - Downloading Program
 - Interfacing between PLC & Various Field Devices
- Duration : 96 Hrs (4 weeks, 4 hrs / day)**
Course Fees : Rs. 8,000/-

C.6 h Advance PLC

- Introduction of Industrial Automation.
 - Details of PLC Hardware (siemens)
 - Concept of FB, FC & DB
 - Operations With Bit Logic, Jump, Math Functions
 - Totally Integrated Automation V13
 - Interfacing With Siemens S7-300 And S7-1500
- Duration : 96 Hrs (4 weeks, 4 hrs / day)**
Course Fees : Rs. 8,000/-

C.6 i SCADA

- Introduction of Ind. Automation
 - Creating a New SCADA App.
 - Details of Process & Internal tags
 - Creating a Process control window with all Applications
- Duration : 96 Hrs (4 weeks, 4 hrs / day)**
Course Fees : Rs. 8,000/-

C.6 j VLSI

- Introduction to VLSI
 - Implementation of Logic In Mosfet, In Front End Design
 - Back End Design, VHDL / VERILOG HDL
 - Live Practice: On Demo Boards
- Duration : 96 Hrs (4 weeks, 4 hrs / day)**
Course Fees : Rs. 8,000/-



C.6 k Embedded Systems

- Introduction
 - Basics of Digital Electronics
 - Basics of 'C' Language
 - Test Equipment
 - Introduction To ARM7
 - LPC 2148 Programming
 - Internal Peripherals of LPC 2148
 - Live Practice: On Demo Boards
- Duration : 96 Hrs (4 weeks, 4 hrs / day)**
Course Fees : Rs. 8,000/-

C.6 l HMI

- Introduction of HMI
 - Comparison Between SCADA & HMI
 - Communication of HMI with PLC
 - Creating & Editing Graphic Display With Animation
 - Database of Tags & Process Tags & Internal Tags
 - Application of Lad Program on HMI
 - Moving object & Alarm System, Multiscreen Tasks
 - Working With online Trend Control
- Duration : 96 Hrs (4 weeks, 4 hrs / day)**
Course Fees : Rs. 8,000/-

C.6 m E-Plan

- Introduction To Eplan
 - Creating Schematic In Eplan
 - Cross References
 - Selection of Parts
 - Macro Concept
 - Layout Drawing
 - Project Management
 - Reports Generation
- Duration : 72 Hrs (3 weeks, 4 hrs / day)**
Course Fees : Rs. 4,500/-

C.6 n Robotics & Automation

- Introduction
 - C++ Programming
 - Lgrob Kit
 - Programming Of Sensors
 - Interfacing With Mo'tors
 - Programming Of Mobile Robot 6 Axis Robot
- Duration : 96 Hrs (4 weeks, 4 hrs / day)**
Course Fees : Rs. 8,000/-



Note : New batches will be started from First Every Monday of every month
Institute reserves right to incorporate changes in course content, duration, intake capacity, no. of batches & course fee without prior notice.
Course Fees Exemption is applicable only for NSQF Exempted short Term Courses for SC/ST Candidates as per the norms

C. SHORT TERM COURSES



C.6 o Sensors & Applications

- Temperature Sensor
- Light Sensor & Ir Sensor
- Pressure Sensor
- LVDT Coil & Load Cell
- Piezo Electric Sensor
- Gas Sensor & Alcohol Sensor

Duration : 48 Hrs (2 weeks, 4 hrs / day)
Course Fees : Rs. 5,500/-

C.6 q 8051 Micro - Controller

- Basics of Digital Electronics
- Basics of 'C' Language
- Test Equipment
- Introduction To 8051
- 8051 Assembly/Embedded C Programming
- Internal Peripherals of 8051
- Live Practice On Demo Boards

Duration : 96Hrs (4 weeks, 4 hrs / day)
Course Fees : Rs. 8,000/-

C.6 p Microprocessor Programming

- Introduction
- Instruction Set
- Assembly Language Programming
- Interfacing
- Programmable Peripheral Interface
- Live Practice: On Demo Boards

Duration : 96 Hrs (4 weeks, 4 hrs / day)
Course Fees : Rs. 8,000/-

C.6 r Basic Mechatronics

- Introduction
- PLC Programming,
- Basic Pneumatics
- Electro Pneumatics,
- Mechatronics Projects Kits

Duration : 192 Hrs (8 weeks, 4 hrs / day)
Course Fees : Rs. 17,000/-

C.6 s Ansys LF

- Introduction
- Maxwell Basic, Geometry Import
- Magnetostatic, EDDY Current Solver
- AC/DC Solver
- Mesh Linking
- Post Processing, Optimization

Duration : 72 Hrs. (3 weeks, 4 hrs / day)
Course Fees : Rs. 9, 000/-

C.6 u MATLAB

- Introduction, Parallel Computing
- Control System Design & Analysis
- Signal Processing & Communication
- Test & Measurement
- Code Generation & Verification
- Application Database Connectivity & Reporting

Duration : 96 Hrs (4 weeks, 4 hrs / day)
Course Fees : Rs. 10,000/-

C.6 w Robotics

- Introduction To Robotics
- Types of Robot
- Actuators & Drives System
- Programming of Robot
- Programming Using Teach box
- Programming Using Software

Duration : 72 Hrs (2 weeks, 4 hrs / day)
Course Fees : Rs. 5,000/-

C.6 t Semiconductor Testing

- Introduction,
- Project Plan, Specifications And Test Program
- Dc Parameters Test
- Functional Test
- Debug Tools And Debugging
- Introduction To Design For Testability

Duration : 72 Hrs (3 weeks, 4 hrs / day)
Course Fees : Rs. 8,000/-

C.6 v A C Drives

- Introduction to Drives
- Difference Between AC Drives & DC Drives
- Study of Various Kinds of Motor
- Application & Speed Control of Motor
- Introduction of Seimens G120 Drive
- Types of Operation & Interfacing with PLC

Duration : 48 Hrs (2 weeks, 4 hrs / day)
Course Fees : Rs.5,500/-

C.6 x Embedded in Robotics & Automation

- Introduction
- C++ Programming
- Arm Basics
- Lpc2148 Programming
- Interfacing of Sensors
- Programming of Mobile Robot 6 Axis Robot

Duration : 144 Hrs (6 weeks, 4 hrs / day)
Course Fees : Rs. 15,000/-



C.6 y Safety System in Autotronics

- Introduction
- Automotive Engine control Management
- AIR Bag System
- Automotive Air Conditioning & Heating System Simulator

Duration : 72 Hrs (3 weeks, 4 hrs / day)
Course Fees : Rs. 10,000/-

C.6 z Engine Management in Autotronics

- Introduction
- Multi Point Electronic Fuel Injection System
- Petrol Engine Test bed
- Common ignition fuel injection
- EFI (Electronic fuel Injection)
- Vehicle Display Principles
- Diesel Engine Test Bed
- Engine Management Principle
- Common Rail Diesel Engine Test Bed

Duration : 72 Hrs (3 weeks, 4 hrs / day)
Course Fees : Rs. 10,000/-

C.6 aa Basics of Process Automation

- Introduction
- Various Sensor
- Process Technology - flow, Pressure & Temperature
- Programmable Logic controller

Duration : 72 Hrs (3 weeks, 4 hrs / day)
Course Fees : Rs. 10,000/-

C.6 ab Electronics in Automobile

- Introduction
- Automotive Electrical Training System
- Simulate The Electrical System on an Automobile
- Anti-lock Breaking System

Duration : 72 Hrs (3 weeks, 4 hrs / day)
Course Fees : Rs. 10,000/-



Note : New batches will be started from First Every Monday of every month
Institute reserves right to incorporate changes in course content, duration, intake capacity, no. of batches & course fee without prior notice.
Course Fees Exemption is applicable only for NSQF Exempted short Term Courses for SC/ST Candidates as per the norms

C-7. 3D PRINTING / SCANNING

C.7 A 3D Printing (Rapid Prototyping)

- Additive Technology & Its Applications
- Additive Manufacturing SLA, SLS, FDM
- Preparing The Model For Rapid Manufacturing
- Materials & Optimizing Manufacturing
- Different Materials & Their Properties
- Adjustment of Parameters
- Time Estimating The Production Time of The Job
- Assembly of The FDM System

Duration : 96 Hrs. (4 weeks, 4 hrs / day)

Course Fees : Rs. 10,000/-

C.7 c Geomagic Scanning

- Basic Modeling Concept
- Knab Modeling without Mesh
- End to End Modeling, Accuracy Analyser
- Modeling Feature, Auto Surface v/s Design

Duration : 72 Hrs. (3 weeks, 4 hrs / day)

Course Fees : Rs. 10,000/-

C.7 B 3D Scanning (Reverse Engineering)

- Scanning Technology
- Different Type of Scanners
- Scanning For Different Type of Objects
- Preparing The Object For Scanning
- Capturing The Cloud Data For Small & Large Objects
- Synthesizing The Model With Overlap
- Modifying The Model To Suit The Design Requirement
- Printing The Model For Checking Form & Fit
- Design Verification Tools

Duration : 72hrs. (3 weeks, 4 hrs / day)

Course Fees : Rs. 10,000/-

C.7 d Rapid Works

- Basic CAD Model
- Assistance to Scan View
- Converting CAD Model for printing

Duration : 72 Hrs. (3 weeks, 4 hrs / day)

Course Fees : Rs. 10,000/-



C.8 WELDING

C8 a Gas Welding

- Introduction to Gas Welding
- Filler Rods
- Gas Cutting operations
- Gas Welding Process

Duration : 96 Hrs. (4 weeks, 4hrs / day)

Course Fees : Rs. 5,500/-

C.8 c MIG/MAG Welding

- Introduction to MIG/MAC Welding
- Welding Positions
- MIG/MAG Welding Process

Duration : 96 Hrs. (4 weeks, 4hrs / day)

Course Fees : Rs. 11,000/-

C.8 e Advance Welding

- MIG Welding
- MAG Welding
- TIG Welding

Duration : 288 Hrs. (12 weeks, 4 hrs / day)

Course Fees : Rs. 22,000/-

C.8 b ARC Welding

- Introduction to ARC Welding
- Introduction Diffrant Welding Electrodes
- Introduction Types of welding machines
- Arc Welding Process

Duration : 96 Hrs. (4 weeks, 4hrs / day)

Course Fees : Rs. 5,500/-

C.8 d TIG Welding

- Introduction to TIG Welding
- Welding Positions
- TIG Welding Process

Duration : 96 Hrs. (4 weeks, 4hrs / day)

Course Fees : Rs. 11,000/-

C.8 f Basic Welding

- Conventional Workshop,
- Arc Welding
- Gas Welding

Duration : 288 Hrs. (12 weeks, 4 hrs / day)

Course Fees : Rs. 22,000/-



C-9. REPAIRS & MAINTENANCE OF ELECTRICAL & ELECTRONIC GADGETS

C.9 a Hand Held Products (HHP)

(Tablets, Mobile Phone, Smart Phone etc.)

- Introduction to Technology
- Working Principles
- Structures
- Types of Technologies
- Assembly & Disassembly
- Repair, Maint. & Trouble Shooting

Duration : 288 Hrs. (12 weeks, 8 hrs / day)

Course Fees : Rs. 15,000/-

C.9 b Audio Video (AV)

(LED, LCD, Plasma TV, Home Theater)

- Introduction to Technology
- Working Principles
- Structures
- Types of Technologies
- Assembly & Disassembly
- Repair, Maint. & Trouble Shooting

Duration : 288 Hrs. (12 weeks, 8 hrs / day)

Course Fees : Rs. 15,000/-

C.9 c Room Air Conditioner & Home Appliances (RACHA)

(Refrigerator, Washing Machine, Oven etc.)

- Introduction to Technology
- Working Principles
- Structures
- Types of Technologies
- Assembly & Disassembly
- Repair, Maint. & Trouble Shooting

Duration : 288 hrs. (12 weeks, 4 hrs / day)

Course Fees : Rs. 20,000/-

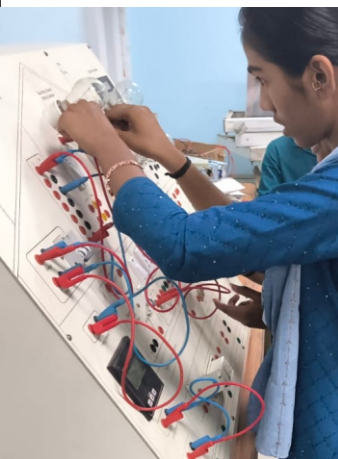

Note : New batches will be started from First Every Monday of every month
Institute reserves right to incorporate changes in course content, duration, intake capacity, no. of batches & course fee without prior notice.
Course Fees Exemption is applicable only for NSQF Exempted short Term Courses for SC/ST Candidates as per the norms

C-10. COMPUTER HARDWARE MAINTENANCE & ADVANCE NETWORKING

C.10 a Computer Hardware Maint. & Networking

- Introduction to Operating Systems
- Computer Peripherals, Memory & Storage
- Assembly and Trouble Shooting
- Introduction to Networking

Duration : 144 Hrs. (12 weeks, 2 hrs / day)

Course Fees : Rs. 12,000/-

C.10 c Traininig Program for MCSE/MCSA Server 2012

- Installing and Configuring & Administering Windows Server 2012(70-410), 2012(70-411) Adv.Windows Server2012(70-412)
- Design.& Implementing a Server Infrastructure (70-413)
- Implementing an Advance Server Infrastructure (70-414)
- Implementing a Desktop Infrastructure & Application (70-415) Environments (70-416)

Duration : 144 Hrs. (12 weeks, 2 hrs / day)

Course Fees : Rs. 12,000/-

C.10 b Advanced Networking

- Applications Software Installation(MS Office, Photoshop, Tally, Antivirus etc.
- Installation of Operating System(Windows XP, Vista, Win 7,Win 8, Server 2003, 2008 R2, 2012, 2012 R2)

Duration : 144 Hrs. (12 weeks, 2 hrs / day)

Course Fees : Rs. 12,000/-

C.10 d C Programming

- Introduction to C
- Getting Started & Environmental Setup
- Program Structure In C
- Basic Syntax In C
- Data Types, Variables & Operators
- Functions, Decision Making
- Loops, Array & Pointers

Duration : 48 Hrs. (4 weeks, 2 hrs / day)

Course Fees : Rs. 1,250/-



C.10 e Participating Program on SAP Business one

- Overview, Purchase, Sales, Pricing
- Items, MRP, Inventory, Project Management
- Bin Location, Service Management
- Introduction to Implementation
- Introduction to Accounting

Duration : 96 Hrs. (3 weeks, 4 hrs / day)

Course Fees : Rs. 10,000/-

C.10 f C++

- Beginning With C++, Tokens , Expressions & Control Structures
- Fuctions In C++,Classes And Objects
- Data Encaptulation & Abstraction
- Inheritance, Polymorphism, Dynamic Binding, Message Passing, Constructor, Destructor

Duration : 48 Hrs. (4 weeks, 2 hrs / day)

Course Fees : Rs. 1,500/-

C.10 g ASP .Net

- Introduction to .net
- Object Oriented Programming
- Graphical User Interface(win Forms)
- Database Connectivity
- Asp.net

Duration : 48 Hrs. (4 weeks, 2 hrs / day)

Course Fees : Rs. 2,500/-

C.10 h JAVA

- Introduction to Java, Getting Started
- Environmental Setup
- Basic Syntax
- Objects & Classes
- Basic Datatypes ,Opt. & Variables
- Modifiers, Decision Making, Loops

Duration : 48 Hrs. (4 weeks, 2 hrs / day)

Course Fees : Rs. 2,500/-

Fundamentals of SAP Business One (NSQF Level 5.5)

- Introduction to SAP
- Purchasing A/P,
- Sales Process
- CRM
- Inventory Process
- Bin Locations
- Production Process
- Financial Setup

Duration : 90 Hrs. Course Fee : 12000/-

Note : SQL & VB. Net Courses conducted on demand with minium 15 participants per batch

C-11. SOLAR TECHNOLOGY

C.11 a Solar PV Installer (Suryamitra)

- Site Survey
- Solar PV System Components
- Installation Solar PV System Components
- Testing & Commissioning
- Maintenance, Health Safety

Duration : 288 Hrs. (6 weeks, 4 hrs / day)

Course Fees : Rs. 12,000/-

C.11 b Solar PV Installer (Electrical)

- Site Survey
- Solar PV System Components
- Installation Electrical Components
- Testing & Commissioning
- Maintenance, Health Safety

Duration : 192 Hrs. (4 weeks, 4 hrs / day)

Course Fees : Rs. 8,000/-

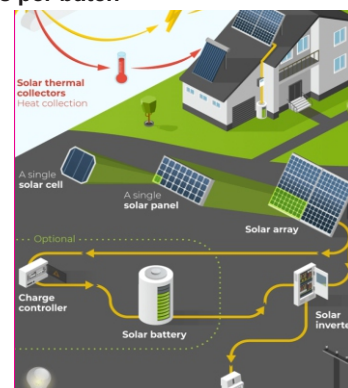

Note : New batches will be started from First Every Monday of every month

Institute reserves right to incorporate changes in course content, duration, intake capacity, no. of batches & course fee without prior notice.

Course Fees Exemption is applicable only for NSQF Exempted short Term Courses for SC/ST Candidates as per the norms

CUSTOM DESIGNED / TAILOR MADE COURSES COURSES FOR FOREIGN NATIONALS

SPECIAL TRAINING PROGRAMME DESIGNED & CONDUCTED : FOR FOREIGN NATIONALS

SR.NO.	COURSE	DURATION
1	ADVANCE COURSE IN TOOL MANUFACTURING & CAD / CAM	24 WEEKS
2	ADVANCE COURSE IN CNC MACHINING (MILLING)	24 WEEKS
3	POST DIPLOMA IN TOOL DESIGN & MANUFACTURING	12 WEEKS
4	DIE & MOULD MFRG. TECHNOLOGY	06 WEEKS
5	ADVANCE COURSE IN TOOL DESIGN & MANUFACTURING	08 WEEKS
6	ADVANCE COURSE IN CNC MACHINING (WIRE CUT)	24 WEEKS
7	ADVANCE COURSE IN DIE & MOULD MANUFACTURING TECHNOLOGY	08 WEEKS
8	COURSE IN CNC PROGRAMMING & MACHINING	12 WEEKS

FOR INDUSTRIAL PROFESSIONALS

SPECIAL TRAINING PROGRAMME DESIGNED & CONDUCTED : INDUSTRIAL PROFESSIONALS



SR.NO.	COURSE	DURATION
1	INT. COURSE IN CAD / CAM / CAE	12 WEEKS
2	BASIC PRACTICES IN FORGING DIE MANUFACTURING	06 WEEKS
3	TOOL/DIE DESIGN & MANUFACTURING	02 WEEKS
4	CNC MILLING & DRILLING OPERATIONS	01 WEEKS
5	INTEGRATED COURSE IN CAD	04 WEEKS
6	CONVENTIONAL MACHINE OPERATIONS (GRINDING)	08 WEEKS
7	BASIC HYDRAULICS	01 WEEK
8	ELECTRO HYDRAULICS	01 WEEK
9	CONV. MACHINE OPERATIONS	08 WEEKS
10	BiW FIXTURE MANUFACTURING	02 WEEKS
11	CNC PROGRAMMING & MACHINING (VMC)	05 WEEKS
12	CNC LATHE & MILLING OPERATIONS	02 WEEKS
13	TOOL DESIGN	06 WEEKS
14	TOOL DESIGN BASICS (INJECTION MOULD DESIGN)	01 WEEK
15	BASIC PNEUMATICS	01 WEEK
16	ELECTRO PNEUMATICS	01 WEEK

Note : Institute reserves right to incorporate changes in course content, duration, intake capacity, no. of batches & course fee without prior notice.

VACATION TRAINING PROGRAMMA FOR ENGINEERING STUDENTS SHORT TERM COURSES (NSQF EXEMPTED)

AREA	MODULE	COURSE	DURATION	REG. FEE	COURSE FEES	SUMMER STARTING DATES	WINTER STARTING DATES
MECHANICAL / PRODUCTION / AUTOMOBILE ENGINEERING OR EQUIVALENT	CAD	AUTOCAD	15 DAYS (6 HRS/DAY)	ONLY REGISTRATION FEE OF RS.354/- IS APPLICABLE TO SC/ST CANDIDATES	₹ 4,500/-	New batches will be started from First, & Third Monday of April, May , June & July	New batches will be started from First, & Third Monday of October, November, December & January
		SOLIDWORKS	15 DAYS (6 HRS/DAY)		₹ 5,500/-		
		CATIA	15 DAYS (6 HRS/DAY)		₹ 8,000/-		
		CREO PARAMETRIC	15 DAYS (6 HRS/DAY)		₹ 8,000/-		
		UNIGRAPHICS	15 DAYS (6 HRS/DAY)		₹ 8,000/-		
	CAM	MASTERCAM	15 DAYS (6 HRS/DAY)		₹ 5,500/-		
		DELCAM	15 DAYS (6 HRS/DAY)		₹ 5,500/-		
		UNIGRAPHICS (CAM)	15 DAYS (6 HRS/DAY)		₹ 8,000/-		
	CAE	ANSYS	15 DAYS (6 HRS/DAY)		₹ 8,000/-		
		HYPERMESH	15 DAYS (6 HRS/DAY)		₹ 8,000/-		
	CNC PROGRAMMING MACHINING	CNC PROGRAMMING LATHE/ MILLING - ANY ONE	15 DAYS (6 HRS/DAY)		₹ 5,000/-		
		CNC MACHINING LATHE/ MILLING / WIRE CUT / EDM - ANY ONE	15 DAYS (6 HRS/DAY)		₹ 6,000/-		
3D PRINTING & SCANNING	3D PRINTING	15 DAYS (6 HRS/DAY)	₹ 5,000/-				
CIVIL / ARCHITECTURAL ENGINEERING	CAD	AUTO CAD CIVIL	15 DAYS (6 HRS/DAY)	₹ 4,500/-			
		3DS-MAX	15 DAYS (6 HRS/DAY)	₹ 6,000/-			
		REVIT ARCHITECTURE	15 DAYS (6 HRS/DAY)	₹ 8,000/-			
	CAE	STAAD PRO	15 DAYS (6 HRS/DAY)	₹ 8,000/-			
ELECTRICAL / ELECTRONICS / INSTRUMENTATION / COMPUTER / MECHANICAL ENGINEERING OR EQUIVALENT B.Sc / M.Sc ELECTRONICS / COMPUTER SCIENCES	AUTOMATION	ELECTRICAL CAD / EPLAN - ANY ONE	15 DAYS (6 HRS/DAY)	₹ 4,500/-			
		PLC PROGRAMMING	15 DAYS (6 HRS/DAY)	₹ 8,000/-			
		SCADA	15 DAYS (6 HRS/DAY)	₹ 8,000/-			
		MICRO-CONTROLLER PROGRAMMING	15 DAYS (6 HRS/DAY)	₹ 8,000/-			
		EMBEDDED SYSTEMS	15 DAYS (6 HRS/DAY)	₹ 8,000/-			
		VLSI	15 DAYS (6 HRS/DAY)	₹ 8,000/-			
		MATLAB	15 DAYS (6 HRS/DAY)	₹ 8,000/-			
COMPUTER SCIENCE / IT ENGINEERING - ANY GRADUATE	COMPUTER APPLICATIONS	JAVA	15 DAYS (2 HRS/DAY)	₹ 2,500/-			
		COMPUTER HARDWARE MAINTENANCE AND NETWORKING	15 DAYS (6 HRS/DAY)	₹ 5,500/-			

OTHER SHORT TERM COURSES

AREA	MODULE	COURSE	DURATION	REG. FEE	COURSE FEES
MECHANICAL / PRODUCTION / AUTOMOBILE ENGG. OR EQUIVALENT	CAE	CFD USING ANSYS FULENT / CFX	15 DAYS (5 HRS/DAY)	FEES EXEMPTION FOR SC/ST CANDIDATE IS NOT APPLIABLE	₹ 11,000/-
	3D PRINTING	3D SCANNING (REVERSE ENGINEERING)	15 DAYS (5 HRS/DAY)		₹ 10,000/-
CIVIL / ARCHITECTURAL ENGG.	SURVEYING	CIVIL SURVEYING USING TOTAL STATION	15 DAYS (4 HRS/DAY)		₹ 7,000/-
ELECTRICAL / ELECTRONICS / INSTRUMENTATION / COMPUTER / MECHANICAL ENGINEERING OR EQUIVALENT B.Sc / M.Sc ELECTRONICS / COMPUTER SCIENCES	AUTOMATION	BASIC HYDRAULICS / PNEUMATICS - ANY ONE	6 DAYS (4 HRS/DAY)		₹ 3,500/-
		ELECTRO HYDRAULICS / PNEUMATICS - ANY ONE	6 DAYS (4 HRS/DAY)		₹ 4,500/-
		ADVANCE PNEUMATICS / HYDRAULICS- ANY ONE	6 DAYS (4 HRS/DAY)		₹ 5,500/-
		ADVANCE PLC PROGRAMMING	15 DAYS (6 HRS/DAY)		₹ 8,000/-
		HMI	15 DAYS (6 HRS/DAY)		₹ 8,000/-
		8051 MICRO CONTROLLER	15 DAYS (6 HRS/DAY)		₹ 8,000/-
		ROBOTICS & AUOMATION	15 DAYS (6 HRS/DAY)		₹ 8,000/-
		EMBEDDED IN ROBOTICS & AUTOMATION	24 DAYS (6 HRS/DAY)		₹ 15,000/-
		MICRO-PROCESSOR PROGRAMMING	15 DAYS (6 HRS/DAY)		₹ 8,000/-
		SENSORS AND APPLICATIONS	12 DAYS (4 HRS/DAY)		₹ 5,500/-
		AC DRIVES	12 DAYS (4 HRS/DAY)		₹ 5,500/-
		AUTOMATION WITH PNEUMATICS USING PLC	24 DAYS (6 HRS/DAY)		₹ 14,500/-
		BASIC MECHATRONICS	30 DAYS (6 HRS/DAY)	₹ 17,000/-	
SEMICONDUCTOR TESTING	15 DAYS (5 HRS/DAY)	₹ 8,000/-			
COMPUTER SCIENCE / IT ENGINEERING - ANY GRADUATE	COMPUTER APPLICATIONS	ROBOTINO	12 DAYS (4 HRS/DAY)	₹ 6,000/-	
		C PROGRAMMING	24 DAYS (2 HRS/DAY)	₹ 1,250/-	
		C++ PROGRAMMING	24 DAYS (2 HRS/DAY)	₹ 1,500/-	
		DOT NET	24 DAYS (2 HRS/DAY)	₹ 2,500/-	
		CCNA	24 DAYS (6 HRS/DAY)	₹ 16,000/-	

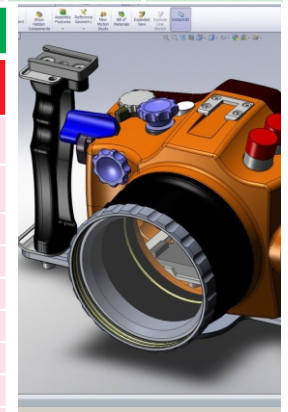

Note : Institute reserves right to incorporate changes in course content, duration, intake capacity, no. of batches & course fee without prior notice. Course Fees Exemption is applicable only of NSQF Compliant Long Term & Medium Term Courses for SC/ST Candidates as per the norms. Before Registration to the courses at extension centres please conform the courses offered by respective extension centres.

NSQF COMPLIANT LONG TERM COURSES

SR. NO.	COURSE	NSQF LEVEL	DURATION HRS.	COURSE COMMENCEMENT	COURSE FEES
1	SR. TOOL DESIGNER - CAD / CAM (POST GRADUATE DIPLOMA IN TOOL DESIGN & CAD/CAM)	6.5	1800	FIRST MONDAY OF JANUARY, APRIL, JULY AND OCTOBER OF CALENDAR YEAR	RS. 90,000/- (RS. 30,000/- PER SEM.)
2	JR. TECHNICIAN - TOOL & DIE MAKER (CERTIFICATE COURSE IN TOOL & DIE MAKING)	3.5	1200		RS. 40,000/- (RS. 20,000/- PER SEM.)

NSQF COMPLIANT MEDIUM TERM COURSES

SR. NO.	TITLE	NSQF LEVEL	DURATION HRS.	COURSE COMMENCEMENT	COURSE FEES
1	TECHNICAL SUPERVISOR - COMPUTER AIDED ENGINEERING (MASTER CERTIFICATE COURSE IN COMPUTER AIDED TOOL ENGINEERING)	5	600	FIRST MONDAY OF EVERY MONTH	RS.35,000/-
2	TECHNICAL SUPERVISOR -ADDITIVE MANUFACTURING (MASTER CERTIFICATE COURSE IN PRODUCT DESIGN)	5	600		RS.35,000/-
3	JUNIOR DESIGNER CAD/CAM (MASTER CERTIFICATE COURSE IN CAD/CAM)	4.5	600		RS.35,000/-
4	JR. DESIGNER – TOOL (MASTER CERTIFICATE COURSE IN TOOL DESIGN)	4.5	600		RS.35,000/-
5	FRONT LINE JUNIOR SUPERVISOR (CONSTRUCTION) (ADVANCE DIPLOMA IN STRUCTURAL DESIGN AND ANALYSIS)	4.5	600		RS.35,000/-
6	ASSISTANT OPERATOR - CNC TURNING - TOOL ROOM	3	600		RS.35,000/-
7	ASST. OPERATOR- CNC MILLING (TOOL ROOM)	3	600		RS.35,000/-

SHORT TERM COURSES

SR. NO.	NAME OF THE COURSE	FULL TIME/ PART TIME	HRS/ DAY	DURATION	COURSE COMMENCEMENT	COURSE FEE (Rs.)
1	Auto CAD (MECH.)	PT	4	96 Hrs.	Note : New Batch will be started from Every Monday	4,500/-
2	Auto CAD (CIVIL)	PT	4	96 Hrs.		4,500/-
3	Solidworks (CAD)	PT	4	96 Hrs.		5,500/-
4	CATIA (CAD)	PT	4	96 Hrs.		8,000/-
5	CREO PARAMETRIC (CAD)	PT	4	96 Hrs.		8,000/-
6	Unigraphics (CAD)	PT	4	96 Hrs.		8,000/-
7	Unigraphics (CAM)	PT	4	96 Hrs.		8,000/-
8	Master CAM (CAD/CAM)	PT	4	96 Hrs.		5,500/-
9	DELCAM (CAD/CAM)	PT	4	96 Hrs.		5,500/-
10	ANSYS	PT	4	96 Hrs.		8,000/-
11	HYPERMESH	PT	4	96 Hrs.		8,000/-
12	CNC PROGRAMMING - MILLING	PT	4	96 Hrs.		5,000/-
13	CNC PROGRAMMING - LATHE	PT	4	96 Hrs.		5,000/-
14	PLC PROGRAMMING	PT	4	96 Hrs.		8,000/-
15	SCADA	PT	4	96 Hrs.		8,000/-
16	VLSI	PT	4	96 Hrs.		8,000/-
17	EMBEDDED SYSTEM	PT	4	96 Hrs.		8,000/-
18	ELECTRICAL CAD	PT	4	96 Hrs.		4,500/-
19	3DS-MAX	PT	4	96 Hrs.		6,000/-
20	REVIT ARCHITECTURE	PT	4	96 Hrs.		8,000/-
21	STAAD PRO	PT	4	96 Hrs.		8,000/-
22	MICRO-CONTROLLER PROGRAMMING	PT	4	96 Hrs.		8,000/-

Note : Institute reserves right to incorporate changes in course content, duration, intake capacity, no. of batches & course fee without prior notice. Course Fees Exemption is applicable only of NSQF Compliant Long Term & Medium Term Courses for SC/ST Candidates as per the norms. Before Registration to the courses at extension centres please conform the courses offered by respective extension centres.

ACADEMIC YEAR ADMISSION & PLACEMENT SCHEDULE

COURSE		DURATION		
LONG TERM COURSES	Advance Diploma Tool & Making	4 YEARS	New Batch Will Be Started From First Monday of August. Every year	
	Diploma in Mechatronics	3 YEARS		
	Certificate Course in Machinist (Tool Room)	2 YEARS		
	Senior Tool Designer – CAD/CAM (Post Graduate Diploma in Tool Design & CAD/CAM)	1800 Hrs (15 Months)	New Batch Will Be Started From First Monday of January, April, July & October. Every year	
	Assistant Mechatronics System Designer (NSQF Level-5) (Post Diploma in Mechatronics)	1200 Hrs (10 Months)		
	Technician Machine Maintenance (Mechatronics) (NSQF Level-4.5) (Advance Certificate Course in Machine Maintenance)	1200 Hrs (10 Months)		
	Jr. Technician Tool & Die Maker (NSQF Level-3.5) (Condensed Course in Tool & Die Making)	1200 Hrs (10 Months)		
Asst. Operator - Conventional Machines (NSQF Level-2.5) (Certificate Course in Machine Operation)	1200 Hrs (10 Months)			
MEDIUM TERM COURSES	Jr. Designer - CAD/CAM (NSQF Level-4.5) (Master Certificate Course in CAD/CAM)	600 Hrs (5 Months)	New Batch Will Be Started From First Monday of February May, August & November Every year	
	Jr. Designer - Tool (NSQF Level-5) (Master Certificate Course in Tool Design)	600 Hrs (5 Months)		
	Technical Supervisor Computer Aided Engineering (NSQF Level-5) (Master Certificate Course in Computer Aided Tool Engineering)	600 Hrs (5 Months)		
	Technical Supervisor -Additive Manufacturing (NSQF Level-5) (Master Certificate Course in Product Design)	600 Hrs (5 Months)		
	CNC Programmer -Tool Room (NSQF Level-4.5) (Master Certificate Course in CNC Technology)	600 Hrs (5 Months)		
	Assistant Operator CNC Turning - Tool Room (NSQF Level-3) (Certificate Course in CNC Turning)	600 Hrs (5 Months)		
	Assistant Operator CNC Milling - Tool Room (NSQF Level-3) (Certificate Course in CNC Milling)	600 Hrs (5 Months)		
	Technician - CNC Machining (NSQF Level-4) (Certificate Course in CNC Machining)	600 Hrs (5 Months)		
	Sr. Technician Mechatronics (NSQF Level-4.5) (Master Certificate Course in Mechatronics)	600 Hrs (5 Months)		
	Sr. Technician Maintenance and Automation (NSQF Level-4.5) (Advance Diploma in Machine Maintenance & Automation)	600 Hrs (5 Months)		
	Process Designer Automation (NSQF Level-5.5) (Master Certificate Course in Automation & Process Control)	600 Hrs (5 Months)		
	Front Line Jr. Supervisor - Construction (NSQF Level-4.5) (Advance Diploma in Structural Design & Analysis)	600 Hrs (5 Months)		
	Technician - Computer Hardware & Network Management (NSQF Level-4)	600 Hrs (5 Months)		New Batch Will Be Started From First Monday of Every Month. Every year
	Jr. Technician (Electronics Equipment) (NSQF Level-3)	600 Hrs (5 Months)		
	Jr. Technician – Welding (NSQF Level-3)	600 Hrs (5 Months)		
	Jr. Technician - Inspection & Quality Control (NSQF Level-3)	600 Hrs (5 Months)		
	Technician - Room Air Conditioner & Home Appliances (NSQF Level-4)	600 Hrs (5 Months)		
Technician - Audio Video Systems (NSQF Level-4)	510 Hrs (4.5 Months)			
Technician - Hand Held Products (NSQF Level-4)	510 Hrs (4.5 Months)			
CISCO Certified Network Associate (NSQF Level-4)	480 Hrs (4 Months)			

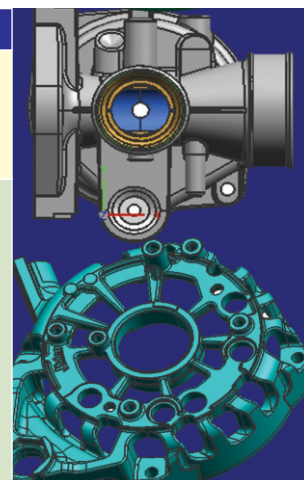

Note For Placement : Three months prior to course completion placement activity shall be started . Selected Trainees will be relieved after course completion only.

IGTR makes efforts to contact & invite companies to conduct campus interviews, however no guarantee can be given for placement / employment.

CUSTOM DESIGNED SPECIAL TRAINING PROGRAMMES CONDUCTED FOR : GOVERNMENT AGENCIES



- MAHATMA JYOTIBA PHULE RESEARCH AND TRAINING INSTITUTE (MAHAJYOTI)
- CHHATRAPATI SHAHU MAHARAJ RESEARCH, TRAINING AND HUMAN DEVELOPMENT INSTITUTE (SARTHI), PUNE
- DR. BABASAHEB AMBEDKAR RESEARCH AND TRAINING INSTITUTE (BARTI), PUNE
- ACADEMY OF MAHARASHTRA RESEARCH, UPLIFTMENT AND TRAINING (AMRUT)
- NATIONAL SC ST HUB, GOVERNMENT OF INDIA
- NATIONAL BACKWARD CLASSES FINANCE AND DEVELOPMENT, GOVERNMENT OF INDIA
- DEPARTMENT OF DEVELOPMENT OF NORTH EASTERN REGION (DONER), GOVERNMENT OF INDIA
- DEEN DAYAL UPADHYAYA GRAMEEN KAUSHALYA YOJANA (DDU-GKY), MORD, GOVERNMENT OF INDIA
- NATIONAL SCHEDULED CASTES FINANCE AND DEVELOPMENT, CORPORATION, GOVERNMENT OF INDIA
- TRIBAL DEVELOPEMENT DEPARTMENT, GOVERNMENT OF MAHARASHTRA
- DIRECTORATE OF TECHNICAL EDUCATION, GOVERNMENT OF MAHARASHTRA
- TRIBAL RESEARCH & TRAINING INSTITUTE, GOVERNMENT OF MAHARASHTRA
- DIRECTORATE OF VOCATIONAL EDUCATION AND TRAINING, GOVERNMENT OF MAHARASHTRA
- DR. BABASAHEB AMBEDKAR RESEARCH AND TRAINING INSTITUTE, GOVERNMENT OF MAHARASHTRA
- MAHARASHTRA STATE BOARD OF TECHNICAL EDUCATION, MUMBAI, GOVERNMENT OF MAHARASHTRA
- MADHYA PRADESH COUNCIL OF EMPLOYMENT AND TRAINING (MAPCET), GOVERNMENT OF MADHYA PRADESH
- NATIONAL BANK FOR AGRICULTURE AND RURAL DEVELOPMENT (NABARD)

INDUSTRIES

- NATIONAL ACADEMY OF DEFENSE, PRODUCTION (NADP),NAGPUR.
- MAHATMA GANDHI INSTITUTE FOR RURAL INDUSTRIALIZATION, MAGANWADI,
- HINDUSTAN AERONAUTICS LTD., NASIK
- HINDUSTAN AERONAUTICS LTD., KORAPUT
- MARUTI UDYOG LTD., NEW DELHI
- L & T LTD., BARODA
- ISCAR INDIA LTD.
- JK FILES LTD., MUMBAI
- M.A FORD & COMPANY LTD., MUMBAI
- MAHINDRA FORGINGS LTD, PUNE
- KIRLOSKAR PNEUMATICS CO. LTD, PUNE
- BHARAT FORGE LIMITED, PUNE
- ENDRESS+HAUSER (INDIA) PVT.LTD.
- GREAVES LTD., AURANGABAD
- SIEMENS ENERGY INDIA LTD., AURANGABAD
- PACKSYS GLOBAL (INDIA) PVT. LTD. MUMBAI.
- JOHNSON & JOHNSON LTD., AURANGABAD
- FORBES LIMITED, AURANGABAD
- COSMO FILMS LIMITED, AURANGABAD
- JOHN DEER INDIA PVT. LTD.PUNE
- VARROC ENGINEERING, AURANGABAD
- NRB BEARINGS LIMITED, AURANGABAD
- EATON TECHNOLOGIES, PUNE
- XYLEM INDUSTRIES, BADODA
- TATA ADVANCE SYSTEM LTD., HYDERABAD
- HIRSCHVOGEL KALYANI INDIA PVT. LTD., PUNE
- CANPACK (I) LTD, AURANGABAD.
- ENDURANCE TECH. PVT LTD., AURANGABAD
- BOSCH INDIA LTD. PUNE
- ACG WORLD WIDE, MUMBAI

INSTITUTES

- SHIVAJI UNIVERSITY, KOLHAPUR
- DR. BATU, LONERE
- BAMU UNIVERSITY,AURANGABAD
- GOVERNMENT COLLEGE OF ENGG., AURANGABAD
- GOVERNMENT COLLEGE OF ENGINEERING, JALGOAN
- GOVERNMENT POLYTECHNIC, LATUR
- JNEC, COLLEGE OF ENGG., AURANGABAD
- MGM COLLEGE OF ENGINEERING, NANDED
- PES COLLEGE OF ENGINEERING, AURANGABAD
- MIT COLLEGE OF ENGG., AURANGABAD
- AMRUTVAHINI COLLEGE OF ENGINEERING, SANGAMNER
- SSG COLLEGE OF ENGINEERING, SHEGAON
- SES COLLEGE OF ENGINEERING, KOPARGAON
- GGSES COLLEGE OF ENGINEERING, BIDAR
- GRAMIN POLYTECHNIC, NANDED
- SGGGS COLLEGE OF ENGINEERING, NANDED
- PADMASHRI DR. VIKHE PATIL COLLEGE OF ENGG., LONI
- SVERI'S COLLEGE OF ENGINEERING, PANDHARPUR
- HI-TECH INSTITUTE OF TECHNOLOGY, AURANGABAD
- S.S,V.P'S B.S.DEORE ENGG. COLLEGE, DHULE
- DEOGIRI COLLEGE OF ENGG., AURANGABAD
- PRAVARA RURAL ENGG.. COLLEGE, LONI
- GURU GOVIND SINGH COLLEGE OF ENGG.& RESEARCH CENTRE, NASHIK
- J D MAHAJAN COLLEGE OF ENGG., NAGPUR
- TERNA COLLEGE OF ENGG., OSMANABAD
- PROF. RAM MEGHE COLLEGE OF ENGG., BADNERA
- PROF. RAM MEGHE INST. OF TECH. BADNERA
- SHIVAJI COLLEGE OF ENGG.,PARBHANI
- P.R.POTE(PATIL) COE & MANAGEMENT, AMRAVATI
- KARMAYOGI COLLEGE OF ENGG.,PANDHARPUR
- SHREYASH COLLEGE OF ENGG., AURANGABAD
- CSMSS COLLEGE OF ENGG.,AURANGABAD
- N.B.NAVLE SINHGAD COLLEGE OF ENGG., SOLAPUR
- SKN SINHGAD COLLEGE OF ENGG.,PANDHARPUR
- ORCHID COLLEGE OF ENGINEERING,SOLAPUR
- SHIVAJI COLLEGE OF ENGINEERING,SANGOLA
- FABTECH COLLEGE OF ENGINEERING,SANGOLA
- K.K. WAGH COLLEGE OF ENGG., NASIK
- EVEREST COLLEGE OF ENGG., AURANGABAD
- WOMEN'S RESIDENTIAL GOVT. POLY., LATUR
- M.S. BIDVE COLLEGE OF ENGINEERING, LATUR
- D.Y. PATIL COLLEGE OF ENGINEERING, PUNE
- SANDEEP INSTUTATE TECHNOLOGY & RESEARCH CENTRE(SITRC), NASHIK

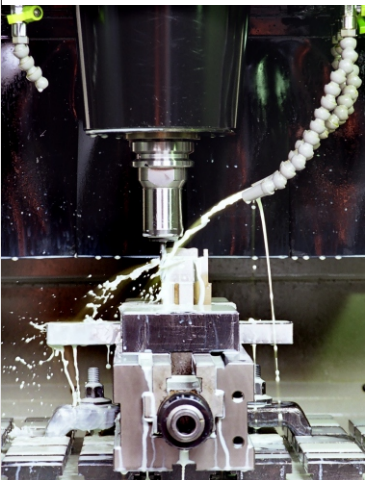

INFRASTRUCTURE AT GLANCE

- TOTAL PLOT AREA - 51878 Sq. Mtr.
- CAPTIVE POWER GENERATION - 2X320 KVA-
- ADMINISTRATION
- TRAINING
- BOYS HOSTEL
- COMMUNITY CENTER
- INTERNATIONAL HOSTEL
- MULTIPURPOSE AUDITORIUM
- SANCTIONED ELECTRIC POWER - 1500 KVA
- CAPTIVE POWER GENERATION-2X320 KVA
- BUILT UP AREA - 25092 Sq. Mtr.
- CENTRAL AIR CONDITION
- COMPRESSED AIR SUPPLY
- PRODUCTION
- GIRLS HOSTEL
- CANTEEN
- RESIDENTIAL COMPLEX
- OVERHEAD & UNDERGROUND WATER RESERVOIRS
- COMPRESSED AIR SUPPLY
- CENTRAL AIR CONDITIONING UNIT

CLEAN, GREEN & DUST FREE ENVIRONMENT



ADMINISTRATION



AUDITORIUM



CANTEEN



TRAINING



PRODUCTION



HOSTEL

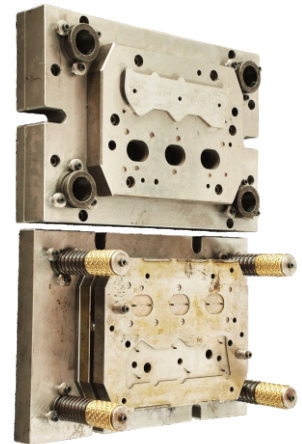

TRAINING

WIDE SPECTRUM OF LATEST & ADVANCE MACHINE SET UP

CNC MILLING

- DECKEL MAHO 50T
- BFW SURYA - VF30
- ACE - MCV350
- ACE - SPARK XL
- JYOTI - PX30
- HAAS - TM1

CNC LATHE

- ACE - JOBBER JUNIOR
- ACE - TUTOR
- ACE - JE 06 LM
- JYOTI - DX 150
- HAAS - TL1

CNC WIRE CUT

- ELECTRONICA - SPRINTCUT
- ELECTORNICA - ECOCUT

CNC SPARK EROSION

- ELECTRONICA - EXPERT
- ELECTRONICA - ZNC

PRECISION SURFACE GRINDER

- PROTH PSGS3060BH
- KENT

SURFACE GRINDER

- KIRLOSKAR
- ELB INDIA

CYLINDRICAL GRINDER

- HMT K 130
- PARISHUDH

TOOL & CUTTER GRINDER

- PRAGA 3197

CONVENTIONAL MILLING

- BFW - UF 2

- BFW - VF 2

- BFW - VF 1

- HMT - FN 1 U MI TR

UNIVERSAL MILLING

- MIKRON WF 3 SA

CONVENTIONAL LATHES

- GEDEE WEILER LZ 350

- KIRLOSKAR ENTERPRISE 380

- KIRLOSKAR ENTERPRISE 355

- HMT NL 22

- PIONEER 350

HYDRAULIC TRAINING KIT

- FESTO (DUAL STATION)
- (BASIC, ELECTRO & ADVANCE)

PNEUMATIC TRAINING KIT

- FESTO (DUAL STATION)
- (BASIC, ELECTRO & ADVANCE)

PLC PROGRAMMING KIT

- SIEMENS S71500
- ALLEN BRADLEY S7300

AUTOMATION

- VLSI
- SCADA
- PCB
- EMBEDDED SYSTEMS
- MECHATRONICS KIT
- 6 AXIS ROBOT
- PROCESS AUTOMATION
- AUTOTRONICS

WELDING

- GAS, ARC
- MIG/MAG/TIG

3D PRINTER

- MARKFORGED MARK 2
- HYREL-3D (HYDRA 16A)
- RXP2200

3D SCANNER

- MLT, 1M, 5.0 MP

SP3D PANTOGRAPH 1GRAVING

- PRECISION ENGL. /MH 45 R

TOTAL STATION

- TRIMBLE SPECTRA 2"

SOLAR PV

- SOLAR PV KIT



PRODUCTION

ULTRAMODERN STATE-OF-THE-ART TOOL ROOM FACILITIES



CNC-5 AXIS HIGH PRECISION MACHINING CENTRE

HERMELE C 32 U

CNC-5 AXIS MILL TURN

HERMELE C 62 MT

CNC-5 AXIS MACHINING

JYOTI - UMILL 6

HERMELE-B 300

HASS UMC 500 SS

CNC MACHINING CENTRE

DECKEL - MAHO DMC 100V

DECKEL - MAHO DMC 70V

DECKEL - MAHO DMC 70V Hi-dyn

HARTFORD HB2150 SG

MAKINO- V33

HAAS - VF2

HAAS - VF1

HAAS - VM6

CNC TURN / MILL

HAAS-ST 20 SSY

CNC MILLING

MIKRON - UME 710

MIKRON - WF - 52D

UNIVERSAL MILLING

MIKRON WF 3 SA, 2 SA

UNION MILLING

HMT M1 TR

BFW UF 2, 3.5

BPW VF 3.5

CNC HIGH PRECISION LATHE

SCHAUBLIN 125 CCN

CNC JIG GRINDING

HAUSER H 45

JIG BORING

HAUSER B-3 DR

CNC SURFACE GRINDER

BLOHM - PLANOMAT HP 408

CNC CYLINDRICAL GRINDER

STUDDER S 33

SCHLEIF SA 5/2 U

PRECISION SURFACE GRINDER

ELB OPTIMAL 8550 ND, 4250 ND

KENT 715 SERIES

KENT WM 263 S Series

JUNG JF 520

CNC WIRE CUT

AGIE CHARMILLES - CUT 400

AGIE CHARMILLES - 440CCS

CHARMILLES ROBOFIL 510

CHARMILLES ROBOFIL 300

CHARMILLES ROBOFIL 290

ELECTRONICA ULTRA CUT S1

ELECTRONICA ULTIMA

CNC SPARK EROSION

CHARMILLES ROBOFORM 20

CHARMILLES ROBOFORM 40

AGIETRON ADVANCE

MITSUBISHI E A 30

HIGH SPEED DRILLING

CHARMILLES ROBODRILL SH 2

3D MANUFACTURING METAL

EOS M 280

3D MANUFACTURING PLASTICS

EOS P 396-SLA

3DS- DLP

3D SCAANER

STEINBICHLER,COMET3D 5M

5M-250-25.0MM

CNC LATHE

GLIDEMEISTER CTX 400 E

HAAS - TL 1

HONOR - V400C

HAAS-SL 20

CENTRE LATHE

WEILER COMMODER, CONDOR

HMT NL 22

GEEDEE WEILER

MECHANICAL PRESS

NARENDRA 3000 KN

ZEULENPODA 1250 KN

HYDRAULIC PRESS

DUNKES TYPE HZS 63

INJECTION MOULDING M/C

L & T DEMAG DL 250 T

BATTENFIELD DBA 100 T

SINGLE & DOUBLE CHAMBER FURNACE

NOLZEN (GERMANY)

HARDNESS TESTER

BRINAL & VICKERS

ROCKWELL

DOUBLE COLUMN MILLING MACHINE

PDC 1832

PDC 1426

QUALITY ASSURANCE

HIGH PRECISION QUALITY ASSURANCE & CALIBRATION SERVICES

CNC CMM

CAL-ZEISS PRISMO VAST 5

BROWN & SHARPE HEXAGON METROLOGY

TOOL MAKER'S MICROSCOPE

CARL-ZEISS (10 x 30x)

PROFILE PROJECTOR

3D SCANNER

RESOLUTION :-2448X2050

Measurement Volume In Mm³:

45 Field-of View : 45x38x30

75 Field-of View : 74x62x45

250 Field-of View : 260x215x140

500 Field-of View : 480x400x250

3D Point Distance In µm:- 45 / 75 / 250 / 500

CO-ORDINATE MEASURING MACHINE

CARL - ZEISS PRISMO VAST 5.

BROWN & SHARPE Hexagaon Metrology

Global Performance 050705

LINEAR HEIGHT MASTER (ELECTRONIC)

MITUTOYO

SURFACE FINISH TESTER

HOMMEL

LASER CALIBRATION SYSTEM

CALIBRATION OF CNC MACHINE LINEAR MOVEMENT ACCURACIES
RENISHAW'S XL-80 FOR LINEAR MEASUREMENT

Successful Placement / Employment



• Many of the IGTR trainees have established their own industry, have been employed abroad in countries like U.S.A. , CANADA, NETHERLANDS, FRANCE, JAPAN HONGKONG AUSTRALIA, SINGAPORE, MALASIA, SOUTH KOREA, PHILIPINES and also pursuing their higher education in India / Abroad.

• IGTR makes efforts to contact & invite companies to conduct campus interviews, however no guarantee can be given for placement / employment.

GENERAL RULES & REGULATIONS FOR TRAINEES

1. Admissions are open for Boys & Girls, eligible candidates will be offered admission on first-come-first-serve basis as per norms.
2. IGTR / Centre reserves the right to reject any application without assigning any reason. Incomplete applications are liable to be rejected.
3. Reservation as per Government of India norms for NSQF compliant courses only.
4. In case of Non NSQF Compliant Courses Tuition Fee / Course Fee exemption will not be applicable for SC / ST Candidates.
5. Candidates belonging to reserved category should substantiate their claim by enclosing a Caste certificate issued by competent authority.
6. Medium of instruction is English only.
7. ***Caste Certificate & all necessary educational certificates in original form issued by competent authority is to be produced for verification at the time of admission which may be re-verified from the issuing authority if required.***
8. Admission to the course will be given only on deposition of registration fee, other fee, first semester tuition/course fee, Security deposit along with submission of relevant educational documents & caste certificate as applicable.
9. **Registration Fee / Course Fee is non-refundable / non-transferrable in case any candidate cancels his admission for any reason.**
10. GST 18% Extra as applicable on registration & Course / Tuition Fees for Non NSQF Complaint Courses will have to be paid by the candidate.
11. **Payment of Fee:** Any fee for admission to the course / Training program should be deposited online through SBI collect option available on <https://www.onlinesbi.com> or can be deposited in the **SBI Power Jyoti Account (Account No. 34008490415)** at any Branch of State Bank of India in the prescribed form (Challan form) available on the IGTR web site. **Registration fee (Non Refundable) to be paid at the time of registration to course**, balance fee (Security Deposit / Course Fee) to be paid on confirmation of admission to the course by IGTR / Centre. No fee will be accepted by Cash/Cheque/D.D.
12. **Course fee once paid will not be refunded under any circumstances.**
13. Security Deposit will be refunded only on successful completion of the course.
14. Admission to the course once confirmed will not be cancelled/transferred under any circumstances & fees paid will be forfeited.
15. **Course fee for the higher / next semester has to be paid within one week from the starting date of semester and all the candidates belonging to SC/ST category have to fill in fresh application form within one week from the starting date of each semester. Late fee will be charged as a fine from the due date as applicable for all trainees.**
16. IGTR / Centre reserves right to incorporate changes in course content, duration, intake capacity, No.of batches & course fee without prior notice. **The course fees as applicable at the starting of the batch / Course will have to be borne by the candidate, including taxes.**
17. Change of batch / Course or Readmission to the courses may be permitted on payment of extra charges as applicable.
18. **Security Deposit Shall be forfeited, in case of loss of original receipt of the security deposit.**
19. Registration Form is for application to the course only for admission purpose.
20. Movement of trainee within the campus shall be restricted to his / her allotted work place.
21. All the trainees will ensure discipline within the campus.
22. Regular attendance will have to be maintained by the trainee as per course schedule & 90% attendance is compulsory in all subjects **individually.**
23. All the internal assessments, assignments, evaluations will have to be attended / completed from time to time as per course schedule only.
24. Working hours are 8 hrs/day(excluding lunch) in different shifts / timing as prescribed by the IGTR / Centre.
25. The machines / Equipment / Furniture must be handled carefully. No act of damage to IGTR / Centre property shall be carried out by the trainee. Any loss or damage to property, fine as charged by management to be paid by the trainee.
26. Trainee have to ensure the proper utilization of IGTR / Centre property including Water & Electricity usage.
27. **Laptop, Mobile phone, Pen Drive, CD or any other related items are not permitted inside IGTR / Centre premises.**

28. Trainee shall be required to wear uniform and shoes as prescribed by the IGTR / Centre and posses I-Card compulsory during training .
29. **Trainees will abide by the examination rules and regulations displayed on Notice Board of IGTR / Centre and as ammended from time to time.**
30. Leave without information / permission will not be entertained.
31. Trainees going on leave or to home during vacation should inform the Course Co-ordinator compulsory.
32. Study material Shall be provided on extra cost as applicable.
33. IGTR / Centre is not responsible for any loss / damage of individual / personal property within around the campus.
34. No trainee shall organize / conduct any meeting within the campus.
35. Smoking & Chewing Tobacco, possesing or drinking Alcoholic beverages in any form is strictly prohibited within IGTR / Centre premises.
36. **Ragging is strictly prohibited in the Premises.**
37. Writing any comment / Remarks/ Name on Doors, Walls, Toilet, Notice Board is strictly prohibited.
38. Violations of above & any other Rules, Regulations, Disciplines and Conduct etc. are liable for disciplinary action.

HOSTEL ACCOMMODATION

Separate hostel facilities may be provided for outstation boys & girls Subject to the availability of the accommodation at the discretion of the institute on extra cost as applicable.

RULES FOR AWARDING OF CERTIFICATE

The evaluation system consists of continuous assessment of each module / subject to assess the performance of trainee. Trainees who qualify in the examination shall be placed in different divisions according to the average marks obtained. **i.e.**

❖ **Distinction >75 %**

❖ **Second Class >50% & <60%**

❖ **First Class > 60% & <75%**

HOW TO REACH

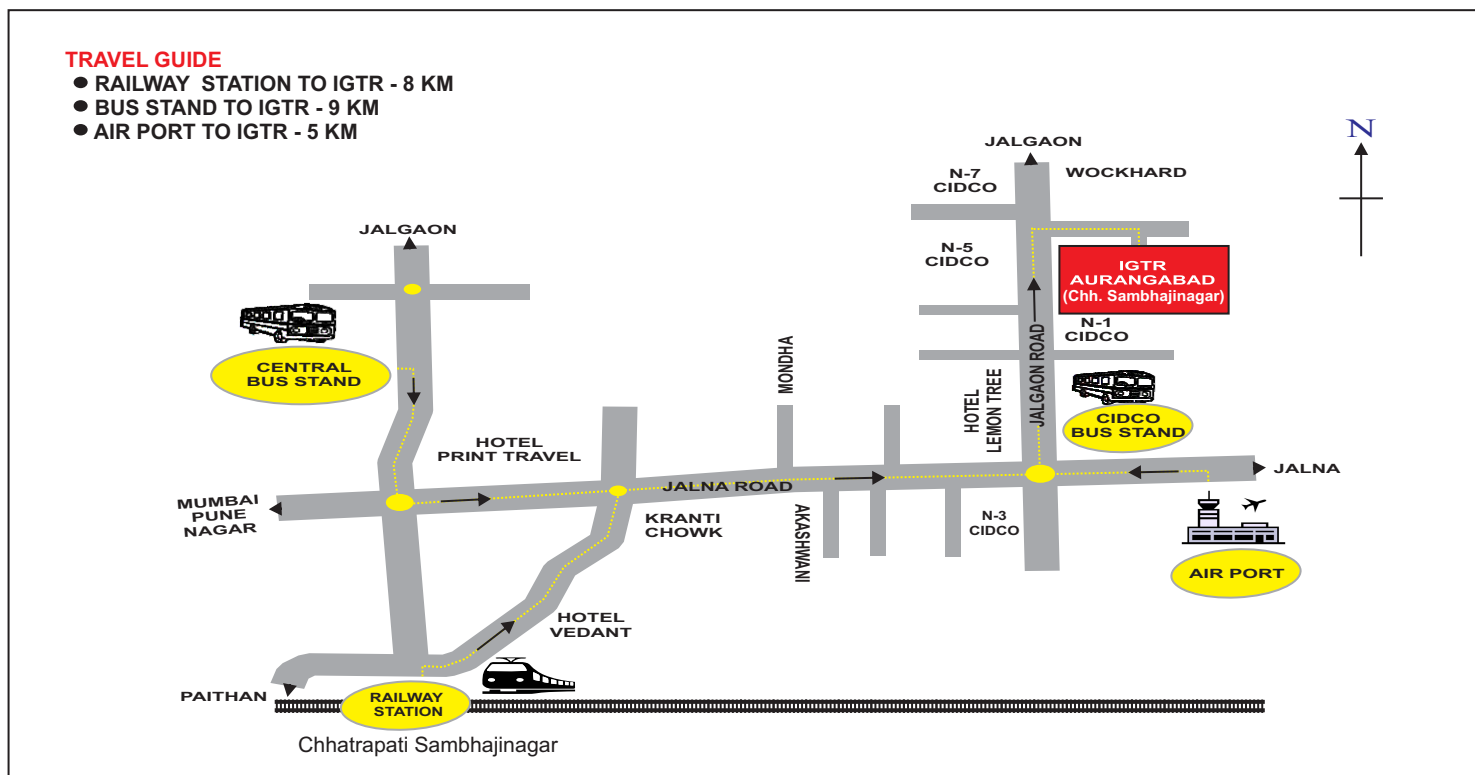



SCAN FOR WEB SITE



SCAN FOR TRAINING ENQUIRY



MSME TECHNOLOGY CENTRE INDO GERMAN TOOL ROOM, AURANGABAD



P-31, MIDC Industrial Area, Chikalthana,

Chhatrapati Sambhajnagar - 431 006 M.S. (INDIA)

Phone : 0240 2610100, Ext.411, 430, 431, 432 (Trg.) 202, 207 (Prod)

Mobile : +91 9373161252, 9373161253 (Trg.) 9373161255 (Prod.)

E-mail : info@igtr-aur.org, training@igtr-aur.org, marketing@igtr-aur.org

Web Site: www.igtr-aur.org



Follow us : Indo German Tool Room - Aurangabad-M.S. @igtrAurangabad.

EXTENSION CENTERS

PUNE - (Swargate)

IGTR - MSME DI CAD/CAM CENTRE
Near PMT Workshop,
Shakarshet Road, M.S, INDIA
Swargate, Pune - 411 037
Phone : 0091 - (020) 24440861, 24440862
E-mail : igtr_pune@yahoo.co.in

PUNE - (Bhosari)

INDO GERMAN TOOL ROOM
Mahasainik Industrial Estate (MSIE)
Plot No T-153/1, MIDC, Bhosari
Pimpri Industrial Area, Pune - 411 026 M.S, INDIA
Phone : 0091 - (020) 27121100, 27121122
E-mail : igtremsie@igtr-aur.org

NAGPUR

INDO GERMAN TOOL ROOM,
P-142, MIDC Hingna,
Nagpur- 440028 M.S, INDIA
Tel. No.: (07104) 297136, 9075095552
E-Mail: training_ngp@igtr-aur.org

KOLHAPUR

“ADVANCED TECHNOLOGY CENTRE”
Shivaji University, Vidya Nagar,
Kolhapur- 416004 M.S, INDIA
Tel. No.: 9325487073
E-Mail: atckolhapur@igtr-aur.org
cdr.adtech@unishivaji.ac.in

MUMBAI

MSME DI-IGTR CAD/CAM CENTRE
MSME Development Institute,
Saki Naka, Kurla - Andheri Road,
Mumbai 400 072 M.S, INDIA
Phone : 0091 - (022) 28573020, 28573024
Email : training_mum@igtr-aur.org

WALUJ (TCEC)

INDO GERMAN TOOL ROOM
Plot No. P-179, MIDC Industrial Area,
Waluj, Chh. Sambhajnagar-431136(M.S.)
Ph.No. 0240-2980985, 2980970
E-mail : igtreccwaluj@igtr-aur.org